

TARVAS

Reloading instructions 2018

Trumpeting Design

Deep wound channel
Outstanding stopping power
Minimal meat loss



Reloading instructions for TARVAS bullets 9.5.2018

Check that you have the latest version from: <http://www.redmoose.eu/reloading-lataus>

Trough out the development project of the bullet we have ensured excellent terminal ballistics = behaviour in the game and accuracy when shot with good quality gun. For this reason, testing has included terminal ballistics in wet phone books as well as on the game and accuracy testing on the range with different loads. For the testing we have used high quality hunting guns so that results would represent what hunters are using in the field. Every Tarvas bullet has been measured before packing.

To ensure best possible result we recommend following general hand loading instructions, and safety rules and instructions given in this manual. The loads given in this manual are for Vihtavuori powders. Since the behaviour of Tarvas bullets is equal to for example Barnes and Naturalis copper bullets the loads are based on values given for these bullets in Vihtavuori reloading manual. Load data has been tested by shooting but not with a pressure gun. Based on the test results we may have slightly different values than on Vihtavuori manual. Although all loads are shown to be safe it is recommended to start loading from starting loads and follow the pressure signs and accuracy. Use max loads with caution. If overpressure signs are detected stop shooting and dismantle the remaining cartridges.

If you are using other powder make than Vihtavuori, refer to reloading manuals and use loads given to solid copper bullets like Barnes TSX, Nosler E-Tip or Lapua Naturalis with corresponding weight. Do not use maximum loads developed for thin jacketed lead core bullets. This is also mentioned for example in Nosler reloading manual for E-Tip bullets.

Best accuracy values are also given in some cases. However, the best accuracy load is varying from gun to gun because of the barrel dynamics. For this reason, try loads up or down from given best accuracy load if you wish to achieve the best possible accuracy. Since Tarvas has unique design which minimizes meat damage, you can use the whole speed potential of your cartridge. The recommended impact speed range is between 550 m/s – 850 m/s. However, we have seen good results even with impact speeds over 900 m/s

Good reloading practices and reloading safety

Since individual hand loading practices, handling and storage of reloading components are beyond our control Red Moose Oy / Ltd disclaim any liability for possible damages which may result from the reloading or use of ammunition reloaded with these bullets

Reloading of cartridges is interesting hobby and allows you to shoot the best possible cartridges built with best components which will suit your gun and hunting
Every Tarvas bullet has been measured and checked before packing to ensure safe and accurate cartridges if loaded with care. All loads in this manual have shown to be safe. Since there is a great variance on guns it is advised to follow good reloading practices which reduce the risk of accidents due to guns or due to human mistake

1. Do not reload when intoxicated. If you are not in condition to drive you are not in condition to reload
2. Do not eat or drink while reloading. Wash your hands before eating
3. Clean all cases. It is difficult to detect possible damages on dirty cases
4. Check that all cases are free from damages, in good condition and same make. Powder volume may vary a lot between different makes which will have influence on chamber pressure and speed variation. If you end up using different makes weight all casings and use those which are as close same weight as possible.
5. Check case lengths and trim the cases according to instructions in this manual
6. Chamfer the inner edge of the casing so that it does not damage the bullet surface when seated. If you have trimmed cases chamfer also the outer edge if not done by the trimming machine
7. When sizing the cases check the case headspace so that you are not over sizing your cases. Instructions on page 4 - 5
8. After sizing clean the cases from sizing grease / oil before priming and charging
9. Check that the primers are according to the given instructions and all same make. Never use unknown primers or mix different makes. Mixing of primers will result to uneven bullet velocity or even dangerous chamber pressure. General recommendation is when LR primer is changed to LRM maximum load has to be reduced by 0.1 g (1.5 grain)
10. Check that powder make and burning rate is according to instructions
11. If you are using other make than Vihtavuori refer to the load instructions in corresponding reloading manual. Never use these values with other makes even if the powder burning rate according to burning rate tables would match with these powders. The specific weight and energy content between different makes may vary a lot and it can result dangerous chamber pressures
12. Never mix different powders. Keep the powder in the original package
13. Do not store the powder in hot and dry or humid places or open. Keep the powder in original package securely closed in room temperature preferably at +16 - +18°C and at relative humidity 55-60%
14. Take only the correct powder pack on the table so that you don't by mistake use incorrect powder
15. If you are not sure or suspect you have used incorrect powder dismantle all cartridges. Do not shoot!
16. Use good quality powder weight and check the calibration and zero before use. Check the powder charge several times before, in between and in the end of charging if you are using a dispenser.
17. Load in sequences. After charging check that all cases have equal level of powder. If not, the reason has to be clarified
18. When loading has been completed, empty the dispenser to correct powder pack. Never leave the powder in the dispenser because later you may not remember what powder you have in the dispenser
19. Follow the reloading instructions. Start the loading from starting load and follow pressure marks, bullet speed and accuracy. Do not start the loading from maximum load.
20. The influence of shorter barrel length can't be compensated by higher load or by using higher burning rate powder with same load. This will always result dangerous chamber pressure
21. When you start to load a new combination load only a few cartridges, test shoot them and follow pressure signs before increasing the load. If over pressure marks are found stop shooting and dismantle all cartridges.
22. Write down all the loads you have used / tested and the results of test shooting. Don't remember your favourite loads, check them from the manual or from your own records

Pressure signs on cases

Since an ordinary hunter or reloader do not have access to test the safety of reloaded cartridges with a pressure gun, we present here a simple way to follow overpressure marks on cases. We do not recommend using unknown, untested cartridges loaded for another gun if you cannot be sure of the safety of these cartridges

When you are reloading, especially new untested combination in your gun, it is advisable to start from starting load and follow the pressure marks on the cases and how the bolt handles when opened. This is actually the only possible way to home check the safety of the cartridges.

Below common overpressure marks on the cases. If you experience any of these signs on your fired cases stop the shooting immediately and dismantle the remaining cartridges. Do not danger your own or surrounding safety!

Cartridge dismantling by kinetic hammer or bullet puller is a must for a hand loader

Normal pressure marks



9,3x62 cases after firing with two different powders at maximum charges → Normal pressure signs with tested gun. Used load

Vihtavuori N140	3.85 g $V_5=745$ m/s
Vihtavuori N540	4.00 g $V_5=770$ m/s

- Primer has not over expanded
- No polishing or ejector pin marks on the case head

Overpressure signs



1. Primer severely over expanded → Severe overpressure
2. Ejector slot mark imprinted on the case head → Severe overpressure
3. Primer expanded T-shape and falls off by slight knock or is loose when extracted from chamber. Primer pocket severely expanded → Dangerous overpressure. NOTE: Case destroyed beyond reuse
4. Crater around firing pin mark → severe overpressure

Other overpressure signs

1. Bolt is stiff when opened and / or case head is polished → Severe overpressure
 2. Bolt does not open → Dangerous overpressure
 3. Primer blow through and / or case rupture causing powder gas exposure on shooter's face → extremely dangerous overpressure. Risk for personal injury and certain eye damage if shot without safety glasses
- ✓ Chamber pressure in a rifle in normal situation is between 3500 – 4200 bars. Although rifles are proof tested against much higher pressures, cases do not withstand extreme pressures.
 - ✓ Pay respect and concern for overpressure since consequences can be serious

Case head space

Above mentioned primer expansion can be result of too big headspace due to over sizing of the case. On a grove type case / chamber headspace is defined by the measure between bolt head (case head) and shoulder between L1 – L2 seen on page 6. If the case is pressed too deep into the sizing die. It will result too short headspace measure on the case. This will allow the case to move forward in the chamber when firing pin strikes the primer. When primer and powder is ignited primer is pressed partly out from the pocket and it expands uncontrolled. When the case backs off due to rising chamber pressure it crushes the primer flat against the bolt head. This will result "over expanded primer" although chamber pressure is normal. This will result also other problems:

- Misfire
- Damage of the case extractor
- Rapture of case

Overpressure signs



There are two kinds of damages found on the case above

1. Headspace between case and chamber has been too big causing the case length to increase during firing

- ✓ Because of case design the lengthwise expansion will always take place in the back end of the case, on the area where thick case bottom is reduced to thin case wall.
- ✓ Due to longitude deformation on this limited area case wall thickness is greatly reduced and the case will crack or even rupture, if not immediately as in this case, it will do so after a couple of reuse

2. This case has also been exposed to severe overpressure and the rear end has greatly expanded

- ✓ One contributing factor may be oversize camber rear end because of eccentricity during chambering

Case sizing is more than just pressing the case into the sizing die. During full sizing die adjustment, it is a good habit to check the degree of sizing. This is done by measuring the case head space before and after sizing. Place a tube or bigger calibre case on the case neck so that it lies against the case shoulder. Measure the length of this combination from the case fired with your gun before sizing and after sizing. The case shoulder should not be pressed down more than 0.1 mm (0.0039"). If the bolt on your rifle does not feel stiff when closed with sized case the best result is achieved when this headspace reduction is zero (0). Back the sizing die up from the case holder until this is achieved or use neck sizing die. Do not over do the sizing it will reduce both the case lifetime and accuracy.

We recommend using either new cases or cases fired in your gun. Avoid using unknown cases. If you use known new, good condition cases fired with another gun you may face problems with the differences in the chamber dimensions. Sizing dies can't always remove all from errors from the cases. In this situation do the sizing always using a full sizing die. Adjust the die so that you will reach same headspace as with a factory new case or that the bolt can be closed easily. If you wish to have best possible accuracy fire these cases once in your gun so that the cases have expanded to the shape of your gun. This is advisable also with factory new cases.

Barrel dimensions influence

All barrels are made according to CIP or SAAMI which define the minimum dimensions for the barrel and maximum dimensions for the cartridge. All commercially sold weapons are inspected and test fired to confirm that they are safely made according to these standards. This leaves some space for the manufacturers to have variations in the barrel dimensions which has major influence on the max pressure and bullet velocity with a given load. Test barrels are always with quite tight dimensions so that they produce a pressure which will not be exceeded with a factory barrel. Because of these differences it is recommended to start load development from starting load and follow pressure signs Use max loads with caution

Barrel diameter

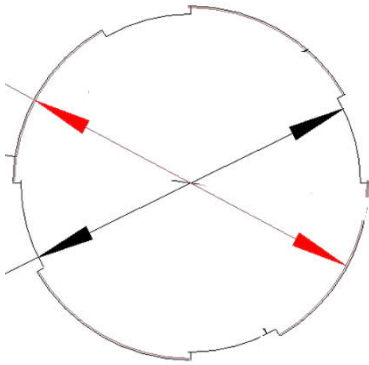

Barrel has two diameters.

1. Drilling diameter or as it is called the small calibre which is measured from the top of the rifling to the top of the rifling
2. Big calibre which is measured from the bottom of the rifling to the bottom of the rifling. This diameter is typically close to the bullet diameter

The big calibre has greatest influence on the pressures and bullet velocity. TARVAS bullets diameter is set to be max the minimum

big calibre defined by standards while lead core bullets may be 0,01...0,02 bigger. This dimensioning together with bullet material, heat treatment and shank groves ensure low chamber pressures

Throat

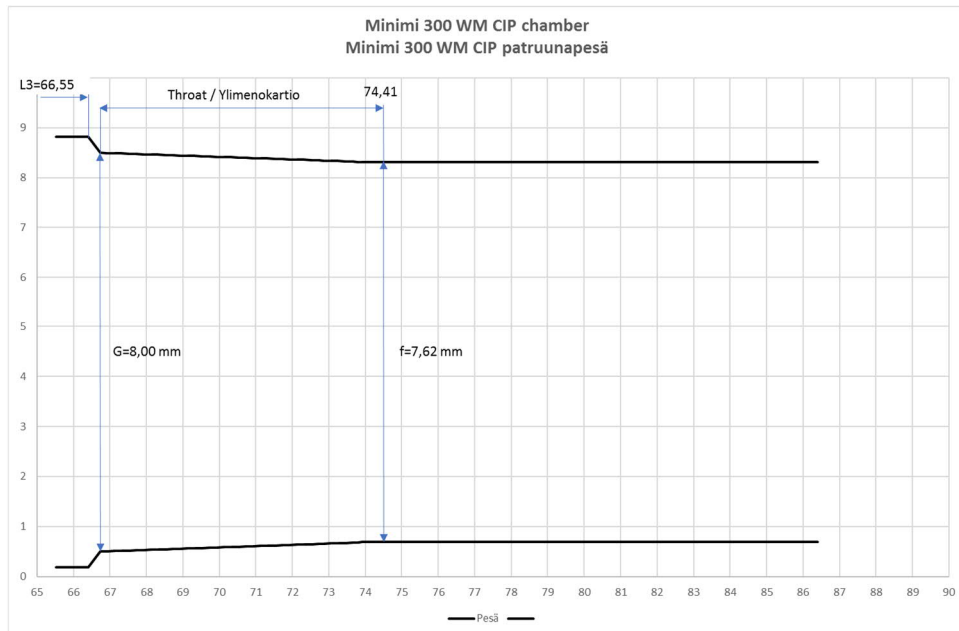

The throat is an area just after the chamber for the case. This area has an area where all rifling is removed and diameter is few 1/100 mm bigger than the bullet max diameter. It continues with a cone shape until it reaches small calibre diameter. This area allows the bullet to seat into the rifling and it delivers some free flight for the bullet before entering the rifling. This is

an area where standards are giving minimum length and manufacturers are making large variations mostly due to safety reasons. Best accuracy for TARVAS bullets is reached when bullet is seated 1 mm of from the rifling. However, in some guns the throat length is so long that magazine or CIP / SAAMI max cartridge length sets the limit how close to rifling bullet can be seated.

With same bullet seating depth and load:

- Long throat and long free flight reduces the pressures and velocity greatly because the long free flight allows the gasses to pass the bullet during the free flight. Good accuracy may be found despite of long free flight.
- Short throat increases pressures and velocity.
- Bullet seated to touch the rifling will increase the pressure and velocity. In case of TARVAS this will deteriorate accuracy.
- Moving of the bullet closer to the rifling contact will increase the pressure and velocity because the gas leakage is reduced

The throat length and free flight has major influence on the bullet velocity reached with given load

Barrel surface quality and fouling

High quality barrels have smooth surface quality and they are almost always lapped.

- Smooth barrel surface reduces chamber pressure
- Smooth barrel surface fouling is greatly reduced
- Rough surface increases chamber pressure and bullet velocity
- Rough barrel fouling is increased and it will deteriorate accuracy and increase chamber pressure
- Cleaning the barrel only with gun oil is not sufficient. To be able to maintain good accuracy bullet material should be removed regularly with chemical or mechanical cleaning.
- TARVAS bullet material is fouling barrels less than copper or tombak.



Barrel length

Barrel length has major influence on the bullet velocity with given load. It does not have influence on the max chamber pressure. A general mistake is to think that powder is not burning completely in a short barrel. This is only partly true. Yes, some powder is left unburned but the biggest question is, has gas expansion taken place or not.

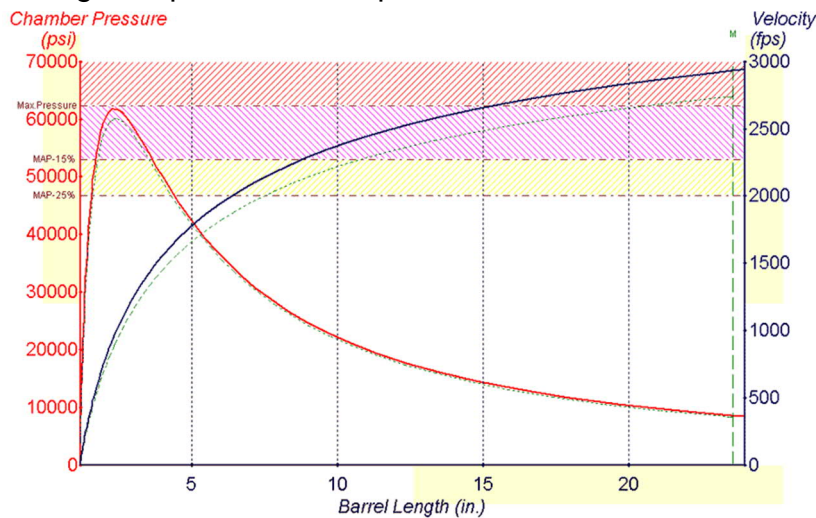

- If the case volume is relatively low and calibre of the bullet is big, volume increases rapidly when bullet is pushed into the barrel. This reduces gas pressure and consequently the required barrel length is short. Typical such calibres are 338 Federal, 9,3x62 and 45-70.
- If the case volume is big and bullet diameter is minor, volume increase and pressure reduction is low when the bullet is pressed into the barrel. The required barrel length is long. Typical such calibres are 6,5x55SE and 300Win Mag.

If barrel is cut short it has a major influence on the achieved velocity with given load. However which calibre is in question has major influence how big velocity change length change is causing

Some examples of barrel length influence to the bullet velocity and minimum recommended barrel length

Calibre	Influence of the barrel length	Minimum barrel length
• 9,3x62	1-2 m/s per 1 cm → 10 cm = 10-20 m/s	50 cm
• 308 Win	3 m/s per 1 cm → 10 cm = 30 m/s	52 cm
• 30-06 SPRG	3 m/s per 1 cm → 10 cm = 30 m/s	58 cm
• 6,5x55SE	3,5 m/s per 1 cm → 10 cm = 35 m/s	60 cm
• 300 Win Mag	4 m/s per 1 cm → 10 cm = 40 m/s	63 cm

Reduction of barrel length does not deteriorate accuracy. In fact, it may improve the accuracy. Shortening of the barrel will always reduce the velocity and max shooting distance.

The action of the gun is fastened from below into the stock. Firing of a round will cause momentum upwards which will create sinus curve vibration on the barrel with vertical major direction. If this vibration takes place with natural frequency of the barrel, accuracy is lost. In a normal case reloader should find a load which creates a barrel vibration that produces smallest groups. This load is not necessarily the one giving lowest speed variation. Barrel dimensioning has major influence on this vibration. The lower amplitude and frequency the better accuracy with a quality barrel. To find a good accuracy with long and small diameter barrel is a challenge.

- Increase of barrel outer diameter will increase bending stiffness which reduces the vibration amplitude and increase of weight reduces frequency
- Shortening of the barrel will reduce the amplitude but it will increase the natural frequency
- Increase of weight reduces natural frequency and amplitude.
 - Mounting of a sound suppressor will increase weight and when correctly designed and assembled it usually increases accuracy in case of a small diameter long barrel. NOTE. Shooters are tempted to shorten the barrel when they assemble suppressor. Keep in mind what was written about recommended minimum barrel lengths
 - Barrel natural vibration frequency and amplitude can be affected by adding weights on the barrel, either fixed or adjustable. These so called tuners have major influence on accuracy
- Because of these vibrations the recommended best load depends greatly of the barrel vibrations. Best accuracy is found usually around the recommended load
- In case of light long barrels it is common that each cartridge and load requires own zeroing of the scope.
- In case of heavy barrels or barrels equipped with suppressor differences are smaller
- In case of heavy barrels or barrels equipped with suppressor differences between different loads are smaller

Below an example of two different barrels with calibre 300 Win Mag. One custom made and one factory, "out of the box rifle"

	Custom	Known quality manufacturer
Bullet	TARVAS Target 155 grain	TARVAS Target 155 grain
Barrel length	70 cm	60 cm
Rate of twist	10"	11"
Big bore	close to min	N/A
Throat	Rifling contact @ 85,4 mm	Rifling contact @ 90 mm
Cartridge length	84,5 mm	84,5 mm
Barrel inner surface	Rough	Smooth

Vihtavuori N165 Load	Custom made 300WM 70 cm barrel	Quality manufacturer 300WM 60 cm barrel
4,70 g		801 m/s
4,80 g	899 m/s	
4,90 g	952 m/s	861 m/s
5,00 g	986 m/s	893 m/s
5,10 g	1002 m/s	918 m/s
5,20 g	1025 m/s	

Measured velocity difference was 80...90 m/s. The difference can be explained

- 40 m/s because of barrel length
- 40...50 m/s because of differences in the throat and barrel inner surface quality

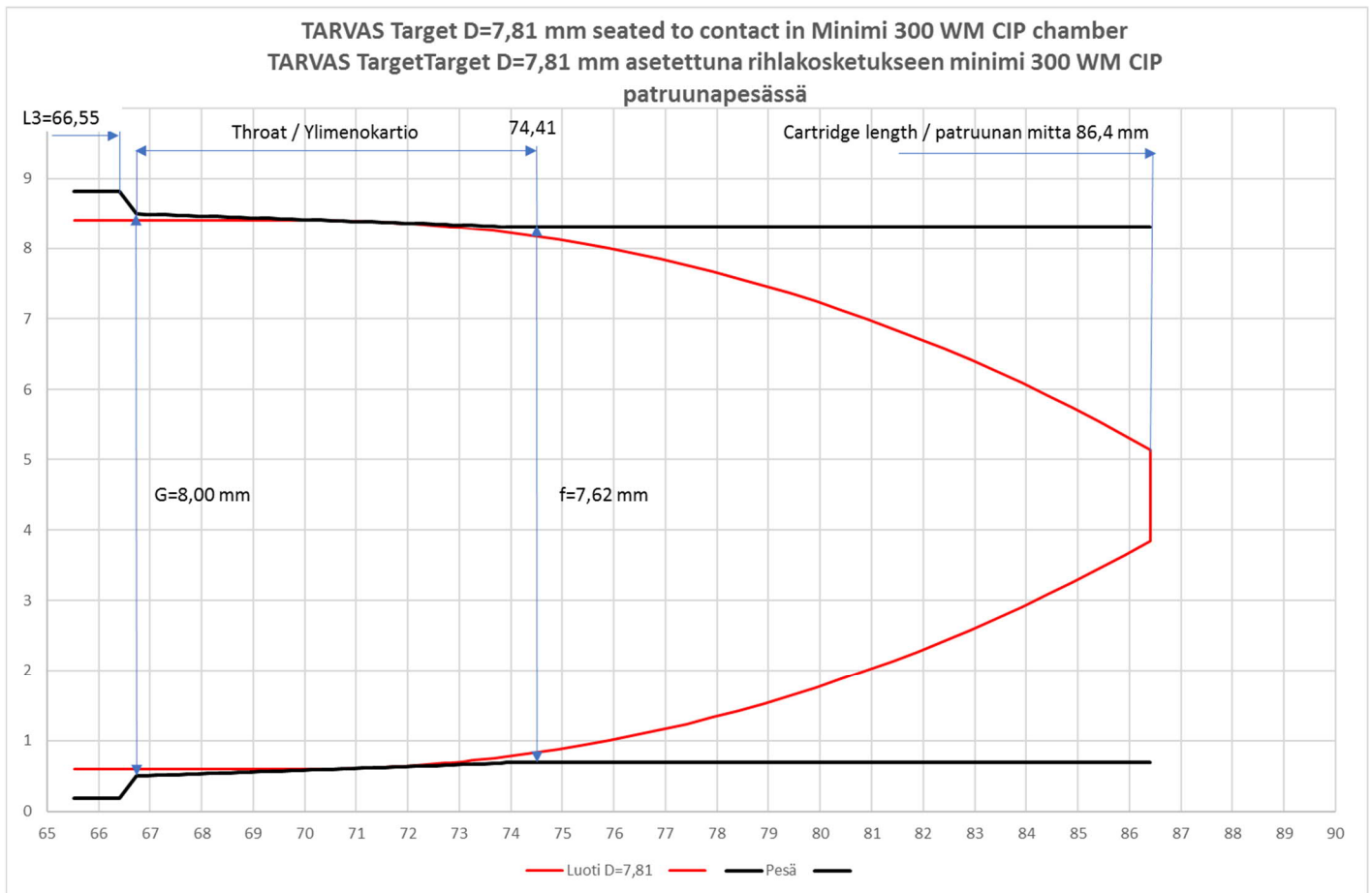

We can look at the above-mentioned case theoretically from the graph where we have placed TARVAS Target bullet geometry with nominal diameter 7,81 mm inside 300 WM CIP min chamber. Calculation shows that bullet comes to contact with rifling at overall length 86,4 mm. Custom made CIP approved barrel contact is reached @ 85,4 mm and in the CIP approved factory made not even @ 90 mm. This means that the custom barrel has slightly shorter throat than CIP min and the factory barrel has clearly longer than CIP min.

Why so big differences? Main reason is safety. If the throat requires clearly longer cartridge length than CIP max or which the magazine still feeds it will reduce the max pressures and give some marginal for mistakes made by a reloader. I have also heard mentioned manufacturing tolerances. However, several millimetres cannot be considered tolerance.

Summary

The reason why measured velocities differ from the manual values can simply be explained with a fact that a responsible testing is always done using standardized test barrel having min dimensions. When these values are used in a commercially manufactured guns differences are coming from

- Barrell length
- Throat dimensions
- How many shot has been fired from the barrel and how much throat erosion
- Big caliber
- Barrel surface quality
- Barrel cleanliness

Rifling contact / Cartridge overall length (COL)

For best accuracy, we recommend seating the bullets 1 mm off from the rifling. Test different seating depths between 0.7 -1.3 mm. This may not be possible with all rifles. In these cases, the overall length is set to ensure flawless feeding from the magazine. Not all weapons are sensitive for seating depth.

The cartridge overall length (COL) which gives best accuracy, is varying from barrel to barrel depending of the throat angle, length and chamber centricity. As an example, my 30-06 AI is shooting 1/3 MOA when the bullet is seated 1-1.2 mm of from the rifling. The other extreme is my 9,3x62 which has a long throat and it shoots ½ MOA groups when loaded 6 mm of from the rifling and COL exceeds CIP max by 1.5 mm.



You can check the rifling contact easily by sizing the case neck partly so that the bullet is softly on the case (not tight). Seat the bullet so that you will reach contact. Close the bolt and open it carefully. Measure the COL and check the contact marks as seen in the picture left. Now seat the bullet deeper so that you have slight contact mark, picture in right and seat the bullet 1 mm shorter from this point. The optional method is to back from the situation in left 1.3-1.5 mm. Normally the best accuracy is found with COL giving 0.7-1.2 mm distance from rifling. Some barrels are extremely sensitive and some insensitive.

If you experience feeding problems reduce the COL by seating the bullet deeper

NOTE:

All testing has shown that if bullet is seated too far to contact rifling it will race pressures and reduce accuracy

COL	Explanation	V5 (m/s)	Group
74 mm	Heavy contact	892 m/s	50 mm
72.3 mm	0.8 mm off from rifling	878 m/s	17 mm

On the next page you will find results of a 5 shot test with different seating depths using CZ 550 Varmint Laminated caliber 308 WIN loaded with 10.7 g / 165 grain Tarvas with 2.80 g N140. This gun was sensitive for the seating depth. To be sure we repeated the test on next day

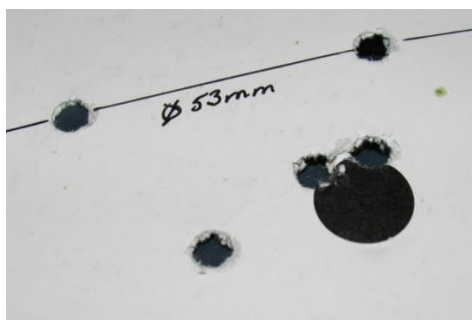

Seating 3 mm off. Groups are 53 mm in both tests

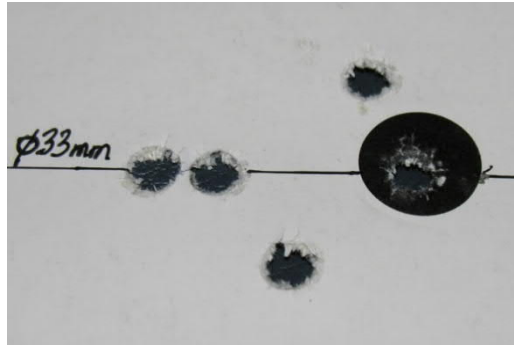
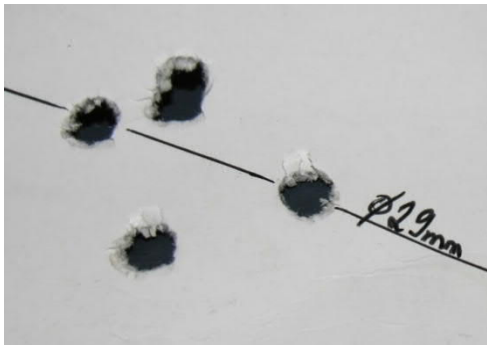

Seating 2 mm off. Much better accuracy around 1 MOA.

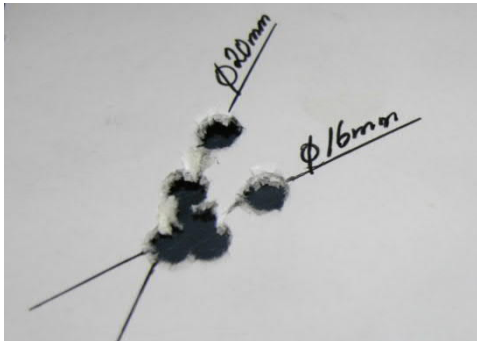

Seating 1 mm off gives $\frac{1}{2}$ MOA groups and even below!



Test cartridges used in this test 3 mm, 2 mm, and 1 mm off from rifling.

Some basic dimensions

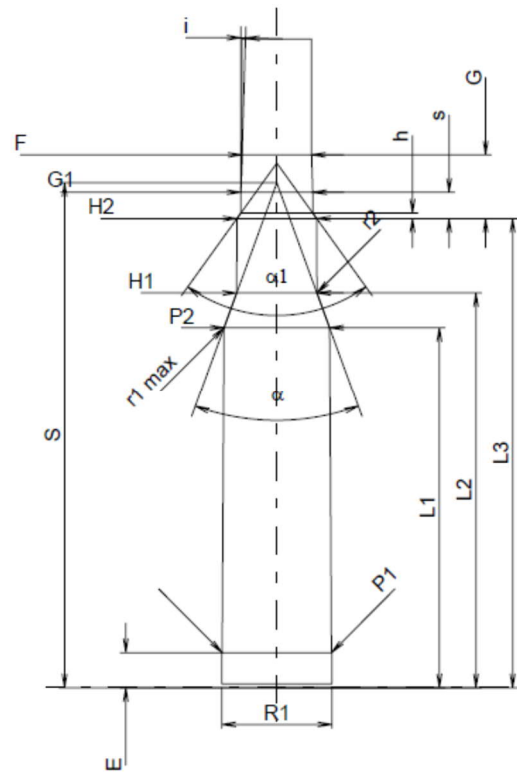
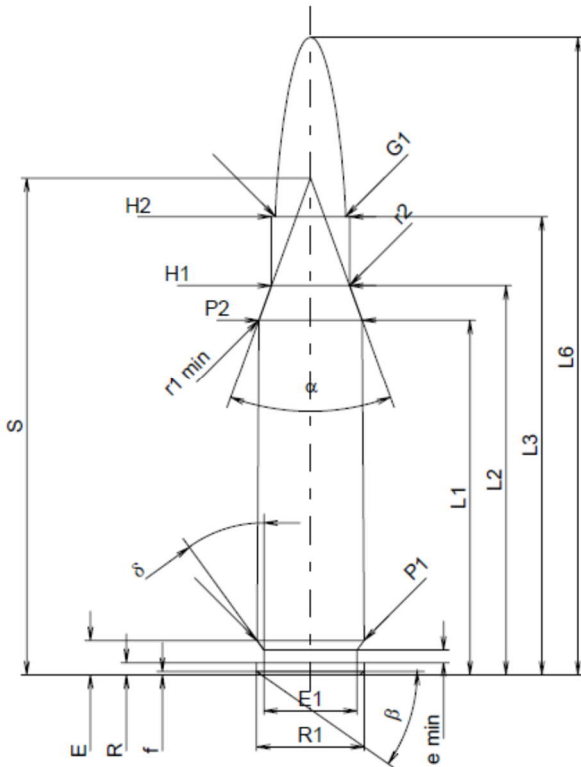

308 Win

Cartridge Maxi (mm)

Chamber Mini (mm)

Head space min ("go")

L1 - L2

L1 - L2

L3 = Case / chamber length

51.18

51.44

Case trim length

L3-0.18 = 51.00

L6 = Cartridge max

71.12

Z = Groove diameter

7.82

F = Bore diameter

7.62

L6 + G = start of bore dia.

58.16

F (7.62) on Tarvas .30

14.04 from bullet nose

COL giving rifling contact

14.04+58.16 = 72.2

Recommended COL

71.00 → seated 1.2 mm of from rifling

Above some basic dimension for 308 WIN according to CIP as an example. The measurement **L3 is the recommended max length of the case**. If the case is longer than chamber **L3** the case neck is pressed on the bullet and results to extreme chamber pressure. For this reason when reloading you should check case length and trim the case to recommended trim length. This is usually 0.2 mm shorter than max recommended case length and 0.4 mm shorter than chamber minimum. **Case trimming is a must when reloading. Never exceed max case length**

Cartridge overall length (COL) L6 which is giving 1 mm clearance from rifling (free flight), can be calculated from CIP chamber throat length and bullet dimensions. Since the standard is only defining max cartridge and min chamber dimensions, length where 1 mm clearance from the rifling is reached may vary from barrel to barrel

CIP defines the **max cartridge length L6**. If your cartridges fit in the magazine, it feeds flawlessly and the bullet is clearly guided by case neck you can exceed this max length provided that the bullet is 1 mm of from rifling

Load data

1 g = 15.43 grain

1 fps = 0.3048 m/s

1' = 12" = 0.3048 m

1" = 25.4 mm

Gram → Grain

Paino 1-2 (g)	Paino (grain)	Paino 2-3 (g)	Paino (grain)	Paino 3-4 (g)	Paino (grain)	Paino 4-5 (g)	Paino (grain)
1	15,4	2	30,9	3	46,3	4	61,7
1,02	15,7	2,02	31,2	3,02	46,6	4,02	62,0
1,04	16,0	2,04	31,5	3,04	46,9	4,04	62,3
1,06	16,4	2,06	31,8	3,06	47,2	4,06	62,6
1,08	16,7	2,08	32,1	3,08	47,5	4,08	63,0
1,1	17,0	2,1	32,4	3,1	47,8	4,1	63,3
1,12	17,3	2,12	32,7	3,12	48,1	4,12	63,6
1,14	17,6	2,14	33,0	3,14	48,5	4,14	63,9
1,16	17,9	2,16	33,3	3,16	48,8	4,16	64,2
1,18	18,2	2,18	33,6	3,18	49,1	4,18	64,5
1,2	18,5	2,2	33,9	3,2	49,4	4,2	64,8
1,22	18,8	2,22	34,3	3,22	49,7	4,22	65,1
1,24	19,1	2,24	34,6	3,24	50,0	4,24	65,4
1,26	19,4	2,26	34,9	3,26	50,3	4,26	65,7
1,28	19,8	2,28	35,2	3,28	50,6	4,28	66,0
1,3	20,1	2,3	35,5	3,3	50,9	4,3	66,3
1,32	20,4	2,32	35,8	3,32	51,2	4,32	66,7
1,34	20,7	2,34	36,1	3,34	51,5	4,34	67,0
1,36	21,0	2,36	36,4	3,36	51,8	4,36	67,3
1,38	21,3	2,38	36,7	3,38	52,2	4,38	67,6
1,4	21,6	2,4	37,0	3,4	52,5	4,4	67,9
1,42	21,9	2,42	37,3	3,42	52,8	4,42	68,2
1,44	22,2	2,44	37,6	3,44	53,1	4,44	68,5
1,46	22,5	2,46	38,0	3,46	53,4	4,46	68,8
1,48	22,8	2,48	38,3	3,48	53,7	4,48	69,1
1,5	23,1	2,5	38,6	3,5	54,0	4,5	69,4
1,52	23,5	2,52	38,9	3,52	54,3	4,52	69,7
1,54	23,8	2,54	39,2	3,54	54,6	4,54	70,1
1,56	24,1	2,56	39,5	3,56	54,9	4,56	70,4
1,58	24,4	2,58	39,8	3,58	55,2	4,58	70,7
1,6	24,7	2,6	40,1	3,6	55,5	4,6	71,0
1,62	25,0	2,62	40,4	3,62	55,9	4,62	71,3
1,64	25,3	2,64	40,7	3,64	56,2	4,64	71,6
1,66	25,6	2,66	41,0	3,66	56,5	4,66	71,9
1,68	25,9	2,68	41,4	3,68	56,8	4,68	72,2
1,7	26,2	2,7	41,7	3,7	57,1	4,7	72,5
1,72	26,5	2,72	42,0	3,72	57,4	4,72	72,8
1,74	26,8	2,74	42,3	3,74	57,7	4,74	73,1
1,76	27,2	2,76	42,6	3,76	58,0	4,76	73,4
1,78	27,5	2,78	42,9	3,78	58,3	4,78	73,8
1,8	27,8	2,8	43,2	3,8	58,6	4,8	74,1
1,82	28,1	2,82	43,5	3,82	58,9	4,82	74,4
1,84	28,4	2,84	43,8	3,84	59,3	4,84	74,7
1,86	28,7	2,86	44,1	3,86	59,6	4,86	75,0
1,88	29,0	2,88	44,4	3,88	59,9	4,88	75,3
1,9	29,3	2,9	44,7	3,9	60,2	4,9	75,6
1,92	29,6	2,92	45,1	3,92	60,5	4,92	75,9
1,94	29,9	2,94	45,4	3,94	60,8	4,94	76,2
1,96	30,2	2,96	45,7	3,96	61,1	4,96	76,5
1,98	30,6	2,98	46,0	3,98	61,4	4,98	76,8
2	30,9	3	46,3	4	61,7	5	77,1

6.5 mm / .264

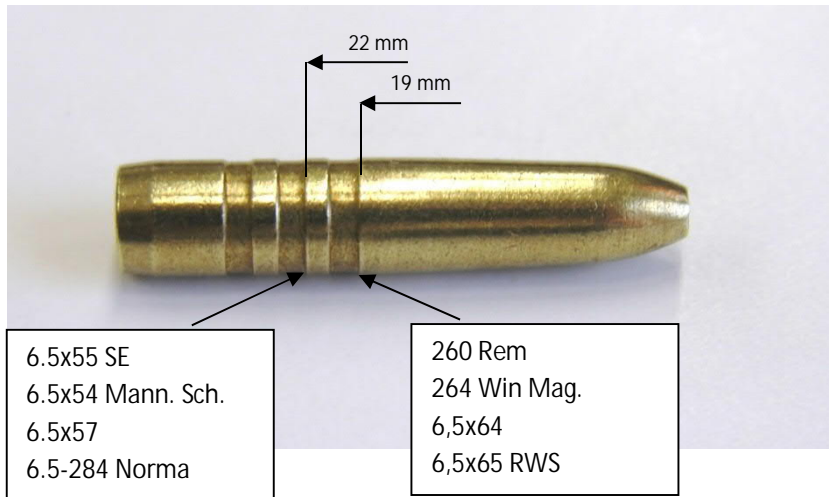

6.5 seating instructions for Tarvas 8.4 g bullet with some general examples for seating when crimping is used. NOTE: Crimping is not obligatory

	6,5x55SE	260 Rem
Cartridge CIP max	80.00 mm	71.12 mm
Case CIP max	55.00 mm	71.70 mm
Case trim length	54.80 mm	71.50 mm
Recommended COL	77.00 mm or 1mm off lands	71.00 mm or 1mm off lands
Recommended twist	8.7" or faster	8.7" or faster
Primer	Large rifle (LR)	Large rifle (LR)

Bullet Tarvas 6.5 mm- 8.4 g / 130 grain

260 Rem	Starting load	Best accuracy	Max load
Vihtavuori N540	2.17 g $V_5=720$ m/s		2.44 g $V_5=810$ m/s
Vihtavuori N550	2.26 g $V_5=720$ m/s		2.59 g $V_5=815$ m/s
Vihtavuori N160	2.32 g $V_5=700$ m/s		2.75 g $V_5=810$ m/s
6.5x55SE	Starting load	Best accuracy	Max load
Vihtavuori N160	2.72 g $V_5=810$ m/s		3.00 g $V_5=880$ m/s
Vihtavuori N560	3.05 g $V_5=830$ m/s	3.10 g $V_5=840$ m/s	3.20 g $V_5=890$ m/s
Vihtavuori N165	3.24 g $V_5=860$ m/s	3.30 g $V_5=890$ m/s	3.35 g $V_5=910$ m/s *)

Best tested

*) Compressed load

Use max load with caution

Do not load lower than minimum loads

.270 (7.04 mm) – 8,4 g / 130 grain

General

This caliber suffers of its twist rate 10" designed for 130 grain / 8,4 g lead core bullets. When shooting long, heavy copper or brass bullets stability becomes an issue. There for if you are planning to build a custom gun or rebarrel your rifle you might find 9" or at least 9,5" twist rate better than the std 10"
The 270 Winchester turns out to be fast and straight shooting caliber. It seems to shoot best with Vihtavuori 160 powder and good qualitu large rifle (LR) primers

.270 8.4 g / 130 grain.

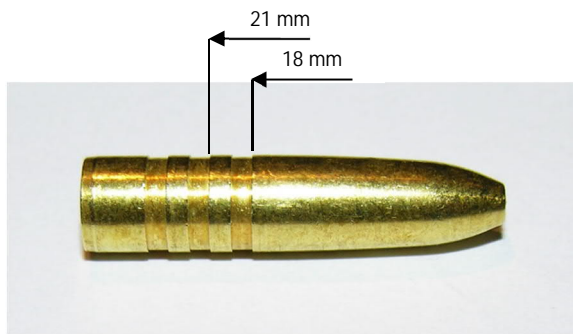

.270 Win

Crtridge CIP max	84.84 mm
Cse CIP max	64.52 mm
Case trim leght	64.30 mm
Cartridge legth COL	84 mm or 1 mm off from rifling
Recomended twist	10" or faster
Primer	Large rifle (LR)

.270 – 8.4 g / 130 grain

.270 Win

Vihtavuori N160	3.30 g V ₅ =859 m/s
Vihtavuori N165	3.50 g V ₅ =845 m/s
Vihtavuori N560	3.50 g V ₅ =845 m/s

Starting load

Best accuracy

3.55 g V₅=916 m/s
3.60 g V ₅ =865 m/s

Max load

3.55 g V ₅ =916 m/s
3.80 g V ₅ =926 m/s
3.73 g V ₅ =921 m/s

.270 (7.04 mm) – 9.1 g / 140 grain

General

This caliber suffers of its twist rate 10" designed for 130 grain / 8,4 g lead core bullets. When shooting long, heavy copper or brass bullets stability becomes an issue. There for if you are planning to build a custom gun or rebarrel your rifle you might find 9" or at least 9,5" twist rate better than the std 10" The 270 Winchester turns out to be fast and straight shooting caliber. It seems to shoot best with Vihtavuori 160 powder and good qualitu large rifle (LR) primers



	.270 Win
Crtridge CIP max	84.84 mm
Cse CIP max	64.52 mm
Case trim leght	64.30 mm
Cartridge legth COL	84 mm or 1 mm off from rifling
Recomended twist	10" or faster
Primer	Large rifle (LR)

.270 – 9.1 g / 140 grain

.270 Win	Aloitustaus	Paras tarkkuus	Maksimilatus
Vihtavuori N160	3.00 g $V_5 = 820$ m/s	3.30 g $V_5 = 870$ m/s	3.30 g $V_5 = 870$ m/s
Vihtavuori N165	3.40 g $V_5 = 825$ m/s	3.60 g $V_5 = 870$ m/s	3.62 g $V_5 = 879$ m/s
Vihtavuori N560	3.30 g $V_5 = 792$ m/s	3.55 g $V_5 = 860$ m/s	3.60 g $V_5 = 886$ m/s

7 mm / .284 - 9,7g / 150 grain

In this caliber we have a small challenge. The barrel dimensions are different on European and US system. Below a table of barrel main dimensions in mm according to CIP standard

	7 mm US System					7 mm European System		
	7-08 Rem.	284 Win	7 mm Rem. Mag.	280 Rem.	7 mm STW	7x57	7x64	7 mm SE
Bore	7,04	7,00	7,04	7,04	7,02	6,98	6,98	6,98
Groove	7,21	7,19	7,21	7,21	7,21	7,24	7,24	7,24
Projectile	7,23	7,21	7,23	7,23	7,23	7,25	7,25	7,24

In a perfect world we would have two different bullets separately for both systems. However this includes a risk to mix these bullets and consequently cause increase of chamber pressure since solid material bullets like Tarvas do not deform in the barrel as easily as lead core bullets. For this reason, as on calibre .30, we have made only one bullet having dimensions according to the US system. When doing so this bullet can be shot in both system barrels safely and without losing accuracy

7 mm 9,7g / 150 grain seating instructions with some general examples for seating and crimping

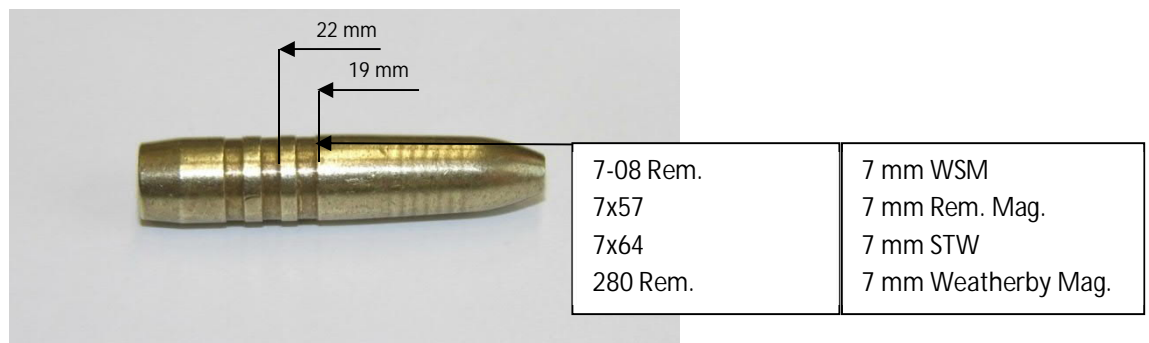

	7-08 Rem	7x57 Mauser	7 mm Rem Mag
Cartridge CIP max	71.12 mm	78.00 mm	83.57 mm
Case CIP max	51.69 mm	57.00 mm	63.50 mm
Case trim length	51.50 mm	56.80 mm	63.30 mm
Recommended COL	71.00 mm	83.50 mm	82.50 mm or 1mm off lands
Recommended twist	10" or faster	10" or faster	10" or faster
Primer	Large rifle (LR)	Large rifle (LR)	Large rifle magnum (LRM)
7-08 Rem	Starting load	Best accuracy	Max load
Vihtavuori N540	2.40 g V ₅ =740 m/s		2.66 g V ₅ =824 m/s
Vihtavuori N550	2.60 g V ₅ =740 m/s	2.85 g V ₅ =825 m/s	2.88 g V ₅ =825 m/s
Vihtavuori N160	2.85 g V ₅ =755 m/s	3.00 g V₅=780 m/s	3.05 g V ₅ =805 m/s *)
7x57 Mauser	Starting load	Best accuracy	Max load
Vihtavuori N550	2.60 g V ₅ =730 m/s		2.90 g V ₅ =810 m/s
Vihtavuori N160	2.90 g V ₅ =760 m/s		3.10 g V ₅ =820 m/s
7 mm Rem Mag	Starting load	Best accuracy	Max load
Vihtavuori N160	3.50 g V ₅ =830 m/s	3.75 g V₅=880 m/s	3.80 g V ₅ =900 m/s
Vihtavuori N165	3.80 g V ₅ =840 m/s		4.10 g V ₅ =925 m/s

Best tested

*) Compressed load

Use max load with caution

Do not load lower than minimum loads

Caliber 30

Note that 7.62x53R and 7.62x39 (Kalashnikov) grooves are 7.91 mm / .311 and bullet diameter 7.85 – 7.91 mm. Caliber .30 bullets are 7.82 mm. These bullets can be shot with caliber 7,62x53R guns safely and with good accuracy. In some cases the 7,62x53R guns are re-barreled with .308 barrels (7.82 mm)

- Tarvas 10.7 g 165 grain can be shot with all caliber 30 guns. Bullet is designed especially for 308 Win
- Tarvas 11.7 g / 180 grain bullet can be shot with all .30 / 7.62 caliber guns with minimum rate of twist 11". Standard rate of twist on 308Win is 12" which is not enough to stabilize 11.7 g Tarvas. Some manufacturers have standardized same rate of twist like Sako and Tikka 11" on all caliber 30 guns. Since penetration on all Tarvas bullets is more than generous 308 Win does not gain anything when shot with the heavier Tarvas which suits better on 30-06 SPRG and 300 magnums

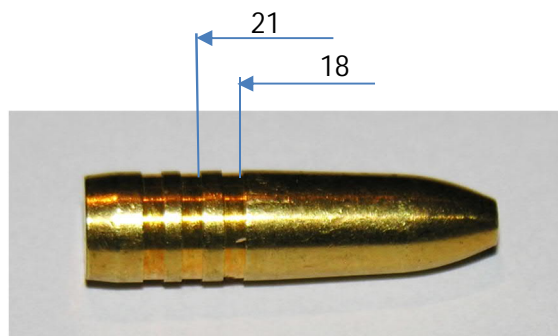

TARVAS Caliber 30 / 150 grain / 9.7 g

	308 Win	30-06 SPRG	7,62x53R
Cartridge CIP max	71.12 mm	84.84 mm	77.00 mm
Case CIP max	51.18 mm	63.35 mm	53.50 mm
Case trim length	51.00 mm	63.10 mm	53.30 mm
Cartridge COL	71.00 mm	83.50 mm	72.50 mm or 1 mm off from rifling
Twist	12" or faster	12" or faster	12" or faster
Primer	Large rifle (LR)	Large rifle (LR)	Large rifle (LR)

308 Win

Start load

Best accuracy

Max load

Vihtavuori N133	2.40 g V ₅ =790 m/s	2.50 g V ₅ =814 m/s	2.60 g V ₅ =831 m/s
Vihtavuori N135	2.60 g V ₅ =810 m/s	2.75 g V₅=860 m/s	2.75 g V ₅ =860 m/s
Vihtavuori N140	2.70 g V ₅ =800 m/s	2.90 g V₅=855 m/s	2.90 g V ₅ =855 m/s
Vihtavuori N540	2.70 g V ₅ =764 m/s	2.85 g V ₅ =820 m/s	2.95 g V ₅ =854 m/s
Vihtavuori N150	2.80 g V ₅ =810 m/s	2.85 g V ₅ =820 m/s	3.00 g V ₅ =865 m/s

7,62x53R

Start load

Best accuracy

Max load

Vihtavuori N135	2.75 g V ₅ =810 m/s		2,93 g V ₅ =860 m/s
Vihtavuori N140	3.00 g V ₅ =810 m/s		3.15 g V ₅ =860 m/s
Vihtavuori N540	2.95 g V ₅ =775 m/s		3.20 g V ₅ =860 m/s
Vihtavuori N150	2.90 g V ₅ =770 m/s		3.23 g V ₅ =870 m/s

30-06 SPRG

Start load

Best accuracy

Max load

Vihtavuori N140	3,10 g V ₅ =809 m/s		3.25 g V ₅ =860 m/s
Vihtavuori N150	3,10 g V ₅ =815 m/s		3.35 g V ₅ =875 m/s
Vihtavuori N540	3.20 g V ₅ =820 m/s		3.30 g V ₅ =865 m/s
Vihtavuori N550	3.30 g V ₅ =800 m/s		3.60 g V ₅ =875 m/s

Paras testatuista

*) Puristuslataus

TARVAS Target .30 / 7.82 mm – 10,0 g / 155 grain

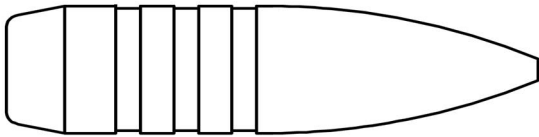

	308 Win	7,62x53R	30-06 SPRG	300 WSM	300 WM
Cartridge CIP max	71.12 mm	77.00 mm	84.84 mm	72.64 mm	84.84 mm
Case CIP max	51.18 mm	53.50 mm	63.35 mm	53.34 mm	66.55 mm
Case trim length	51.00 mm	53.30 mm	63.10 mm	53.10 mm	66.30 mm
Cartridge length COL	71.00 mm	73.50 mm	83.50 mm	84.30 mm	84,7 mm
Bullet contact	1 mm off	1 mm off	1 mm off	1 mm off	1 mm off
Rate of twist (Min)	12"	12"	12"	12"	12"
Primer	LR	LR	LR	LRM	LRM

308 Win

Starting load

Vihtavuori N135	2.40 g V ₅ =770 m/s
Vihtavuori N140	2.60 g V ₅ =790 m/s
Vihtavuori N150	2.70 g V ₅ =800 m/s

Best accuracy

2.60 g V₅=840 m/s
2.78 g V₅=840 m/s
2.90 g V₅=850 m/s

Max load

2.60 g V ₅ =840 m/s
2.85 g V ₅ =866 m/s
2.92 g V ₅ =860 m/s

7,62x53R

Starting load

Vihtavuori N135	2.60 g V ₅ =817 m/s
Vihtavuori N140	2.80 g V ₅ =788 m/s
Vihtavuori N150	2.80 g V ₅ =780 m/s

Best accuracy

3.00 g V₅=860 m/s
3,10 g V₅=860 m/s

Max load

2,90 g V ₅ =885 m/s
3.10 g V ₅ =885 m/s
3.20 g V ₅ =890 m/s

30-06 SPRG

Starting load

Vihtavuori N140	3,10 g V ₅ =809 m/s
Vihtavuori N150	3,10 g V ₅ =815 m/s

Best accuracy

Max load

3.20 g V ₅ =865 m/s
3.30 g V ₅ =880 m/s

300 Win Mag**

Starting load

Vihtavuori N160	4,30 g V ₅ =937 m/s
Vihtavuori N560	4.70 g V ₅ =945 m/s
Vihtavuori N165	4.80 g V ₅ =899 m/s

Best accuracy

4,30 g V₅=937 m/s**
5,00 g V₅=1016 m/s**
4,90 g V₅=952 m/s**

Max load

4.50 g V ₅ =960 m/s**
5,00 g V ₅ =1016 m/s**
5,10 g V ₅ =1005 m/s**

** 70 cm piippu

Paras testatuista

*) Puristuslataus

Käytä maksimi latausta harkiten

Älä lataa minimilatauksia alempia latauksia

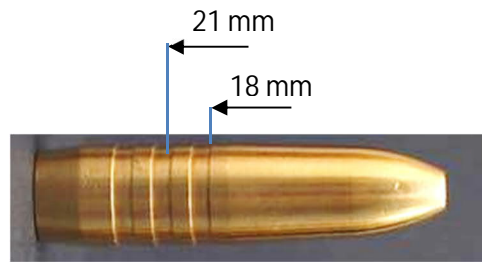

TARVAS caliber 30 / 165 grain / 10.7 g

Instructions when crimping is used. NOTE: crimping is not obligatory

	308 Win	30-06 SPRG	7,62x53R
Cartridge CIP max	71.12 mm	84.84 mm	77.00 mm
Case CIP max	51.18 mm	63.35 mm	53.50 mm
Case trim length	51.00 mm	63.10 mm	53.30 mm
Recommended COL	71.00 mm	83.50 mm	72.50 mm or 1mm off lands
Recommended twist	12" or faster	12" or faster	12" or faster
Primer	Large rifle (LR)	Large rifle (LR)	Large rifle (LR)

308 Win

	Starting load
Vihtavuori N135	2.45 g V ₅ =730 m/s
Vihtavuori N140	2.60 g V ₅ =740 m/s
Vihtavuori N540	2.70 g V ₅ =740 m/s
Vihtavuori N150	2.60 g V ₅ =720 m/s
Vihtavuori N550	2.80 g V ₅ =740 m/s

Best Accuracy

2.52 g V ₅ =755 m/s
2.80 g V₅=795 m/s
2.85 g V ₅ =800 m/s
3.05 g V ₅ =815 m/s

Max load

2.60 g V ₅ =775 m/s
2.85 g V ₅ =810 m/s
2.93 g V ₅ =835 m/s
2.90 g V ₅ =815 m/s
3.10 g V ₅ =830 m/s***

7,62x53R

	Starting load
Vihtavuori N140	2.80 g V ₅ =755 m/s
Vihtavuori N540	2.95 g V ₅ =775 m/s
Vihtavuori N150	2.90 g V ₅ =770 m/s

Best Accuracy

3.00 g V₅=810 m/s

Max load

3.05 g V ₅ =820 m/s
3.20 g V ₅ =845 m/s
3.15 g V ₅ =845 m/s

30-06 SPRG

	Starting load
Vihtavuori N140	2.85 g V ₅ =750 m/s
Vihtavuori N150	2.90 g V ₅ =750 m/s
Vihtavuori N550	3.20 g V ₅ =760 m/s
Vihtavuori N160	3.50 g V ₅ =760 m/s

Best Accuracy

3.45 g V₅=830 m/s
3.60 g V₅=810 m/s

Max load

3.10 g V ₅ =805 m/s
3.15 g V ₅ =825 m/s
3.50 g V ₅ =845 m/s
3.75 g V ₅ =840 m/s

300 Win Mag **

	Aloitustaus
Vihtavuori N160	4.10 g V ₅ =830 m/s
Vihtavuori N560	4.70 g V ₅ =893 m/s
Vihtavuori N165	4.50 g V ₅ =847 m/s

Paras tarkkuus

4,35 g V₅=875 m/s**
4,90 g V₅=949 m/s**
4,70 g V₅=885 m/s**

Maksimilataus

4.50 g V ₅ =910 m/s**
4,90 g V ₅ =949 m/s**
4.90 g V ₅ =941 m/s**

Best tested

***Compressed load

Use max load with caution

Do not load lower than minimum loads

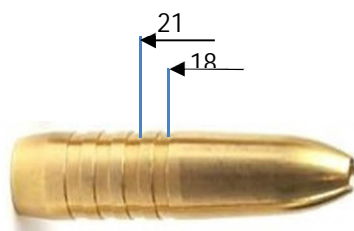

Tarvas caliber 30 / 11.7 g / 180 grain

	308 Win	7,62x53R	30-06 SPRG	300 WSM	300 Win Mag
Cartridge CIP max	71.12 mm	77.00 mm	84.84 mm	72.64 mm	84.84 mm
Case CIP max	51.18 mm	53.50 mm	63.35 mm	53.34 mm	66.55 mm
Case trim length	51.00 mm	53.30 mm	63.10 mm	53.10 mm	66.30 mm
Recommended COL	71.00 mm	72.50 mm	83.5 mm/	84.30 mm	or 1mm off lands
Recommended twist	11" or faster	11" or faster	11" or faster	11" or faster	11" or faster
Primer	LR	LR	LR	LRM	LRM

Kaliiberilla 308 Win suosittellemme ampumaan 165 grain / 10,7 g Tarvas luotia

308 Win

	Aloitustaus	Paras tarkkuus	Maksimilataus
Vihtavuori N140	2.60 g $V_5=710$ m/s		2.77 g $V_5=770$ m/s
Vihtavuori N540	2.63 g $V_5=700$ m/s		2.82 g $V_5=780$ m/s
Vihtavuori N150	2.70 g $V_5=720$ m/s		2.85 g $V_5=775$ m/s
Vihtavuori N550	2.80 g $V_5=720$ m/s	3.00 g $V_5=780$ m/s	3.05 g $V_5=795$ m/s ***

7,62x53R

	Aloitustaus	Paras tarkkuus	Maksimilataus
Vihtavuori N140	2.80 g $V_5=710$ m/s		3.00 g $V_5=780$ m/s
Vihtavuori N540	2.85 g $V_5=715$ m/s		3.00 g $V_5=790$ m/s
Vihtavuori N150	2.80 g $V_5=710$ m/s		3.03 g $V_5=780$ m/s
Vihtavuori N550	3.10 g $V_5=720$ m/s		3.30 g $V_5=815$ m/s ***

30-06 SPRG

	Aloitustaus	Paras tarkkuus	Maksimilataus
Vihtavuori N150	2.75 g $V_5=750$ m/s		3.07 g $V_5=790$ m/s
Vihtavuori N550	3.20 g $V_5=750$ m/s	3.37 g $V_5=815$ m/s	3.40 g $V_5=820$ m/s
Vihtavuori N160	3.40 g $V_5=760$ m/s		3.60 g $V_5=815$ m/s
Vihtavuori N560	3.50 g $V_5=740$ m/s	3.85 g $V_5=820$ m/s	3.85 g $V_5=825$ m/s

300 WSM

	Aloitustaus	Paras tarkkuus	Maksimilataus
Vihtavuori N560	4.00 g $V_5=805$ m/s	4.35 g $V_5=880$ m/s	4.35 g $V_5=880$ m/s
Vihtavuori N165	4.05 g $V_5=800$ m/s	4.35 g $V_5=850$ m/s	4.45 g $V_5=870$ m/s

300 Win Mag

	Aloitustaus	Paras tarkkuus	Maksimilataus
Vihtavuori N160	4.05 g $V_5=830$ m/s		4.40 g $V_5=875$ m/s
Vihtavuori N560	4.70 g $V_5=870$ m/s		4,80 g $V_5=910$ m/s
Vihtavuori N165	4.45 g $V_5=840$ m/s		4.80 g $V_5=885$ m/s

Best tested

***Compressed load

Use max load with caution

Do not load lower than minimum loads

30-06 Ackley Improved 40°

NOTE: This is a "wild cat" which corresponds 300 H&H magnum values. DO NOT USE THESE VALUES ON 30-06 SPRG!

Barrel: Krieger 62.5 cm twist 10"

NOTE: Recommended barrel min. 62 cm to reach the real potential of this caliber

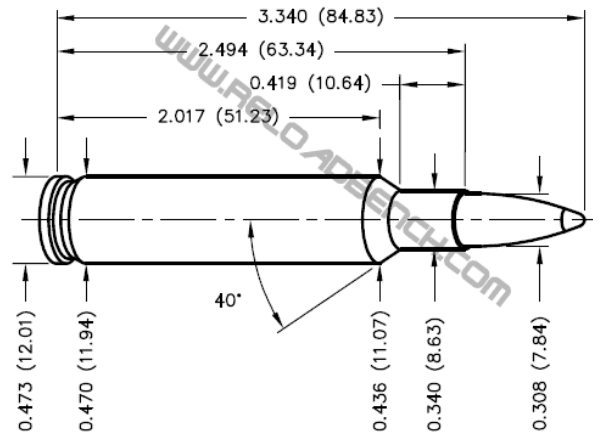

30-06 Ackley Improved 40

Cartridge CIP max	84.84 mm
Case CIP max	63.35 mm
Case trim length	63.10 mm
Recommended COL	83.5 mm / 1mm off lands***)
Recommended twist	11" or faster
Primer	Large rifle (LR) or Large rifle magnum (LRM). If LRM primer is used load has to be reduced 0.1 g

***) Some 30-06 AI reamers are giving extremely short throat which may result to shorter cartridge length. If cartridge length is significantly reduced from test guns COL=83,5 mm we recommend reducing the max load

TARVAS Target 10,0 g / 155 grain (Vaadittu nousu 12")

30-06 AI	Aloitustaus	Paras tarkkuus	Maksimilataus
Vihtavuori N150	3,20 g V ₅ =847 m/s	3.45 g V₅=910 m/s	3,45 g V ₅ =910 m/s
Vihtavuori N160	3,70 g V ₅ =870 m/s	3.85 g V₅=901 m/s	3.90 g V ₅ =918 m/s

Tarvas 10.7 g / 165 grain. (Min rate of twist 12")

30-06 AI	Starting load	Best accuracy	Max load
Vihtavuori N160	3.60 g V ₅ =800 m/s	3.90 g V₅=870 m/s	3.90 g V ₅ =875 m/s

Tarvas 11.7 g / 180 grain. (Min rate of twist 11")

30-06 AI	Starting load	Best accuracy	Max load
Vihtavuori N560	3.70 g V ₅ =800 m/s	4.00 g V₅=860 m/s	4.00 g V ₅ =860 m/s
Vihtavuori N165	3.80 g V ₅ =805 m/s	3.80 g V ₅ =805 m/s	4.05 g V ₅ =850 m/s***

Best tested

***Compressed load

Use max load with caution

Do not load lower than minimum loads

.338

General

13.0 g / 200 grain is designed to all 338 caliber guns. It is well suited on 338 Federal and other small case 338 versions. On 338 WM it gives good performance with reduced recoil and still without meat damage

The 14.6 g / 225 grain version is well suited on all Magnums giving extremely good ballistics on long shots. Since all 338 magnum calibers are having big case volume, the recommended min barrel length is 62 cm to utilize the whole potential of the cartridge. If a shorter barrel is used bullet speed is reduced by 3-4 m/s / 1 cm → 10 cm shorter barrel will lose 35 m/s.

338 seating instructions for Tarvas 13.0 g bullet with some general examples for seating when crimping is used. NOTE: Crimping is not obligatory

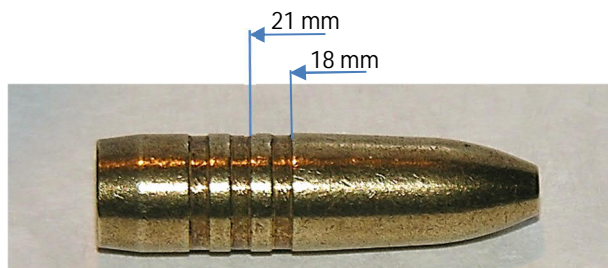

	338 Win Mag	338 Federal	338-06 A-Square
Cartridge CIP max	84.84 mm	71.63 mm	87.38 mm
Case CIP max	63.50 mm	51.18 mm	63.35 mm
Case trim length	63.30 mm	51.00 mm	63.10 mm
Recommended COL	83.60 mm	71.00 mm	85.00 mm
Recommended twist	12" or faster	12" or faster	12" or faster
Primer	Large rifle magnum (LRM)	Large rifle (LR)	Large rifle (LR)

338 Federal	Starting load	Best accuracy	Max load
Vihtavuori N133	2.50 g V ₅ =710 m/s	2.80 g V ₅ =775 m/s	2.80 g V ₅ =785 m/s
Vihtavuori N135	2.60 g V ₅ =710 m/s	2.85 g V₅=785 m/s	2.90 g V ₅ =795 m/s
Vihtavuori N140	2.80 g V ₅ =720 m/s		3,00 g V ₅ =770 m/s

338-06 A-Square	Starting load	Best accuracy	Max load
Vihtavuori N140	3.20 g V ₅ =747 m/s	3.40 g V ₅ =792 m/s	3.40 g V ₅ =792 m/s
Vihtavuori N540	3.30 g V ₅ =753 m/s	3.50 g V ₅ =806 m/s	3.50 g V ₅ =806 m/s
Vihtavuori N150	3.30 g V ₅ =775 m/s	3.50 g V ₅ =810 m/s	3.50 g V ₅ =810 m/s
Vihtavuori N550	3.40 g V ₅ =734 m/s	3.70 g V₅=820 m/s	3.70 g V ₅ =820 m/s

338 Win Mag	Starting load	Best accuracy	Max load
Vihtavuori N550	3.80 g V ₅ =780 m/s		4.35 g V ₅ =880 m/s
Vihtavuori N160	4.25 g V ₅ =770 m/s	4.75 g V₅=880 m/s	4.80 g V ₅ =890 m/s

Best tested

*) Compressed load

Use max load with caution

Do not load lower than minimum loads

Tarvas .338 - 14.6 g / 225 grain



338 seating instructions for Tarvas 14.6 g bullet with some general examples for seating when crimping is used. NOTE: Crimping is not obligatory

	338 Win Mag	338 Federal	338-06 A-Square
Cartridge CIP max	84.84 mm	71.63 mm	87.38 mm
Case CIP max	63.50 mm	51.18 mm	63.35 mm
Case trim length	63.30 mm	51.00 mm	63.10 mm
Recommended COL	83.60 mm	71.00 mm	85.00 mm
Recommended twist	10" or faster	10" or faster	10" or faster
Primer	Large rifle magnum (LRM)	Large rifle (LR)	Large rifle (LR)

Tarvas 14.6 g / 225 grain

	Starting load	Best accuracy	Max load
338-06 A-Square			
Vihtavuori N150	3.20 g V ₅ =724 m/s	3.20 g V ₅ =724 m/s	3.37 g V ₅ =775 m/s
Vihtavuori N550	3.35 g V ₅ =731 m/s	3.60 g V₅=800 m/s	3.60 g V ₅ =800 m/s
Vihtavuori N160	3.70 g V ₅ =740 m/s		3.95 g V ₅ =785 m/s *)
338 Win Mag			
Vihtavuori N550	3.80 g V ₅ =750 m/s		4.30 g V ₅ =840 m/s
Vihtavuori N160	4.25 g V ₅ =750 m/s	4.65 g V₅=825 m/s	4.75 g V ₅ =845 m/s
Vihtavuori N560	4.50 g V ₅ =770 m/s		4.85 g V ₅ =830 m/s *)
338 Lapua Mag			
Vihtavuori N160	4.75 g V ₅ =790 m/s		5.35 g V ₅ =880 m/s
Vihtavuori N560	5.20 g V ₅ =820 m/s		5.75 g V ₅ =915 m/s
Vihtavuori N165	5.00 g V ₅ =800 m/s		5.80 g V ₅ =900 m/s

Best tested load

*) Compressed load

Use max load with caution. Do not load lower than minimum loads

9,3x62 Mauser

In most of the CIP std. Barrels the throat is so long that it is impossible to seat the bullet as close as 1 mm of the rifling. In these cases, the max seating depth is based on COL which is still feeding from the magazine. CIP max length can be exceeded if the magazine length and bullet is seated deep enough in the neck to give adequate guidance.

Measured rifling contacts:

Sako 75 COL = 90 mm (Bullet is not in the case). Magazine feeds 84 mm

CZ 550 COL = 92 mm (Bullet is not in the case). Magazine feeds 85,5 mm

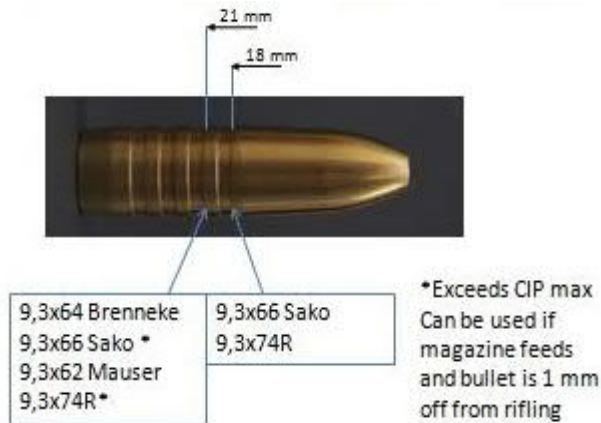

TARVAS caliber 9.3 mm / 250 grain / 16.2 g

Instructions when crimping is used. NOTE: crimping is not obligatory

	9.3x62	9.3x74R	9.3x66 Sako
Cartridge CIP max	83.6 mm	95.00 mm	85.00 mm
Case CIP max	62.00 mm	74.60 mm	66.00 mm
Case trim length	61.80 mm	74.50 mm	65.80 mm
Recommended COL	83.60 mm	94.50 mm	85.00 mm
	or 1mm off lands	or 1mm off lands	or 1mm off lands
Recommended twist	14" or faster	14" or faster	14" or faster
Primer	Large rifle (LR)	Large rifle (LR)	Large rifle (LR)
9.3x62	Starting load	Best accuracy	Max load
Vihtavuori N135	3.21 g V ₅ =680 m/s		3.46 g V ₅ =725 m/s
Vihtavuori N140	3.65 g V ₅ =715 m/s	3.85 g V ₅ =745 m/s	3.80 g V ₅ =745 m/s
Vihtavuori N540	3.70 g V ₅ =725 m/s	4.00 g V₅=770 m/s	4.00 g V ₅ =770 m/s
9.3x74R	Starting load	Best accuracy	Max load
Vihtavuori N135	3.20 g V ₅ =660 m/s		3.45 g V ₅ =710 m/s
Vihtavuori N140	3.60 g V ₅ =670 m/s	3.70 g V₅=710 m/s	3.80 g V ₅ =730 m/s
Vihtavuori N540	3.60 g V ₅ =700 m/s	3.80 g V ₅ =725 m/s	3.85 g V ₅ =740 m/s
9.3x66	Starting load	Best accuracy	Max load
Vihtavuori N140	3.50 g V ₅ =710 m/s		4.00 g V ₅ =780 m/s
Vihtavuori N540	3.84 g V ₅ =740 m/s		4.15 g V ₅ =810 m/s
Vihtavuori N550	4.15 g V ₅ =760 m/s		4.37 g V ₅ =810 m/s *)

Best tested

*) Compressed load

Use max load with caution

Do not load lower than minimum loads

Instructions when crimping is used. NOTE: crimping is not obligatory

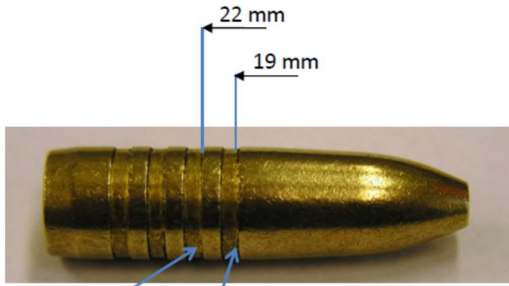

375 Flanged	375 H&H 375 Ruger
----------------	----------------------

375 H&H data

Cartridge CIP max 91,44 mm
 Case CIP max 72,39 mm
 Case trim length 72,20 mm
 Max cartridge length can be exceeded if magazine feeds and bullet is 1 mm off from rifling

375 H&H Magnum

Barrel Sako 62 cm twist 12"
 Case Sako trimmed to 72.2 mm
 Bullet Tarvas 17.5 g / 270 grain
 Primer Winchester LRM
 COL 91.4 mm or bullet seated 1 mm off from rifling

	Starting load	Best accuracy	Max load
Vihtavuori N140	Start 4.00 g V ₅ =710 m/s		Max 4.50 g V ₅ =790 m/s
Vihtavuori N540	Start 4.20 g V ₅ =740 m/s		Max 4.70 g V ₅ =820 m/s
Vihtavuori N150	Start 4.25 g V ₅ =720 m/s		Max 4.70 g V ₅ =800 m/s

Use max load with caution
 Do not load lower than minimum loads