

INTERMITTENT CLOTH PULLERS, PULLERIT

SP90-TR, RF, FJS, FBS, FA, FU, BL

Rollers, Studs, Timing Belts, Roller Lifters - Vetorullat, kiinnitysosat, hammashihnat, nostovaijerit

SP90-series



INTERMITTENT CLOTH PULLERS, PULLERIT

Attachments

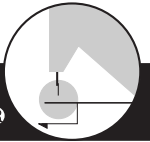

PULLERS RELEVABLES
PULLER INTERMEDIO

INTERMITTIERENDE STOFFPULLER
间歇拉布器

SUISEI®

SP90-TR

Intermittent Cloth Puller, Top Puller Type «For Flat Bed Sewing Machines»
YLÄPULLERI TASOKONEILLE

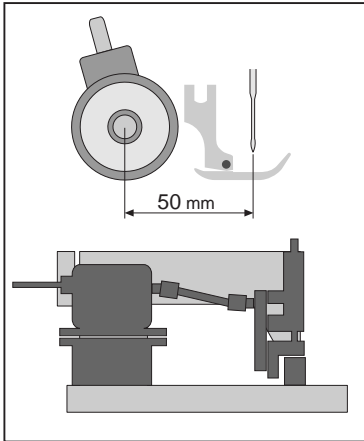

- Rear open space on sewing machine. Appropriate for sewing bulky articles, like down jackets, overcoats and even feather quilts.

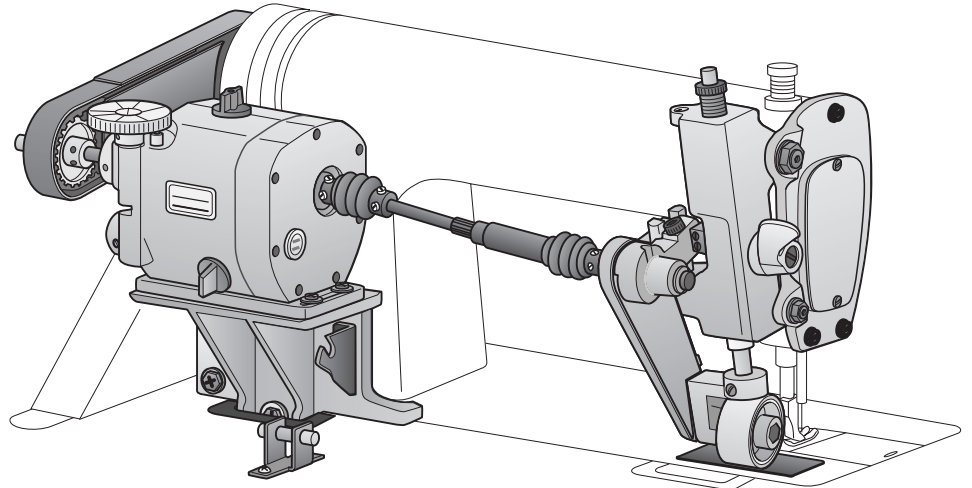
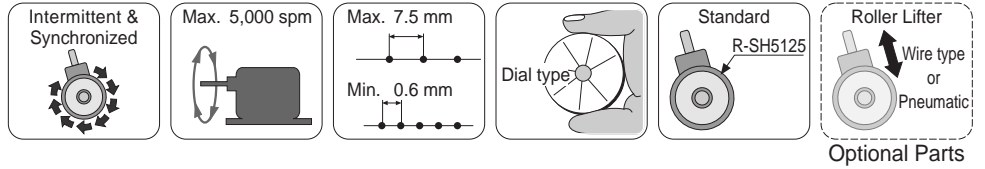

Please specify **model number** of sewing machine when ordering.

SP90-RF

Intermittent Cloth Puller, Direct Drive Type «For Flat Bed Sewing Machines»
TASOKONEILLE

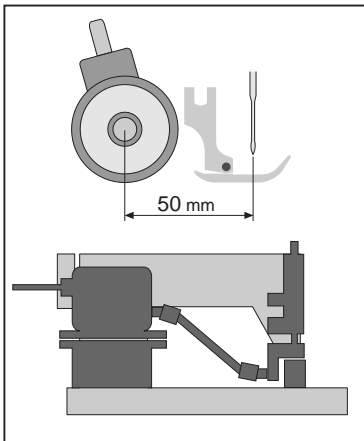

- Roller is directly driven by universal joint. Enough strong to pull light to heavy materials, like shirts, jeans, leather, etc.

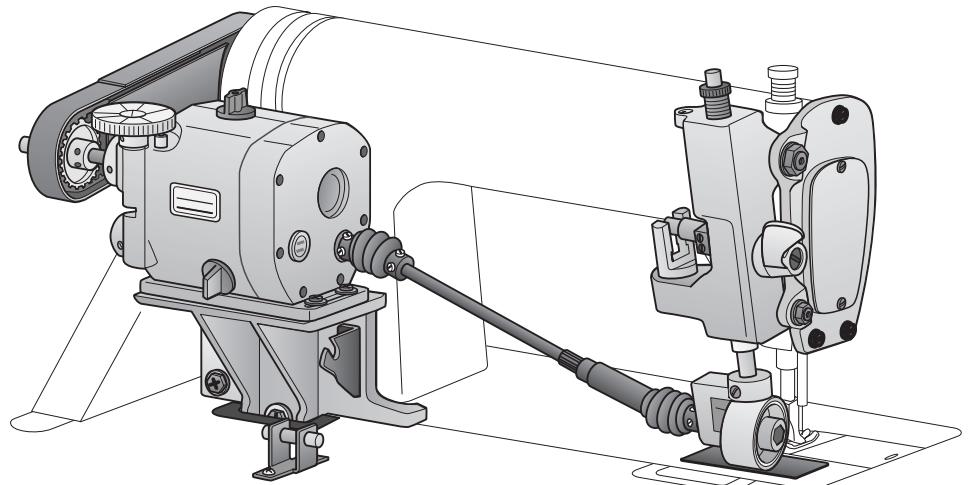
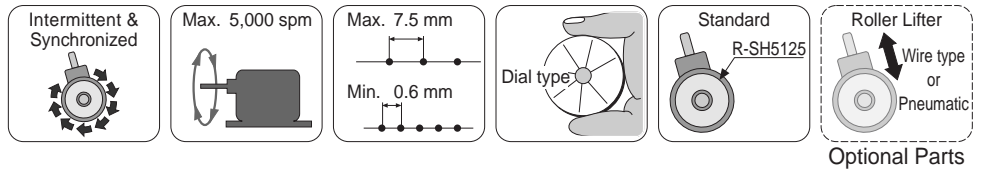

Please specify **model number** of sewing machine when ordering.

INTERMITTENT CLOTH PULLERS, PULLERIT

Attachments

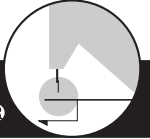

PULLERS RELEVABLES
PULLER INTERMEDIO

INTERMITTIERENDE STOFFPULLER
间歇拉布器

SUISEI®

SP90-FJS, FA Intermittent Cloth Puller for Feed Off The Arm Machine «Face Plate Type» FBS, FU VAPAAVARSIKONEILLE

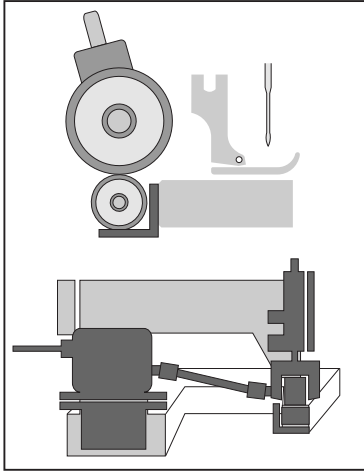

- For Feed Off The Arm machine. Appropriate for sewing tubular articles, like jeans and side-seams on shirts.

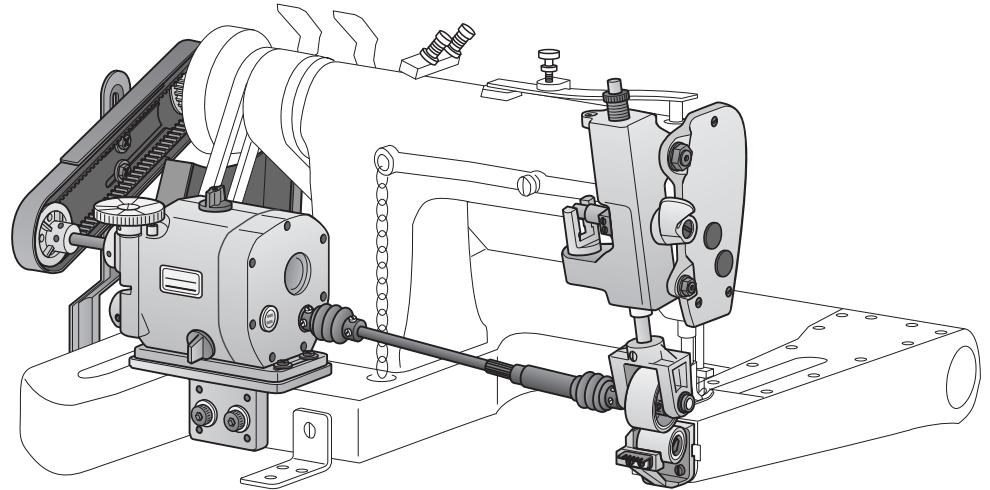
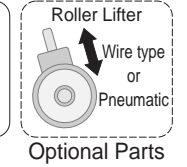
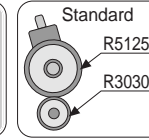
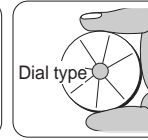
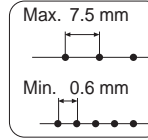
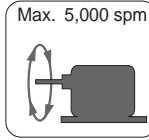
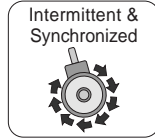

SP90-FJS
JUKI MS-191, MS-261

SP90-FA
TOYOTA L2512

SP90-FBS
BROTHER DT2-B925, B926

SP90-FU
SINGER 261U

TARKISTA KONEEN MALLI NUMERO ENNEN TILAUSTA

Please specify **model number** of sewing machine when ordering.

SP90-BL Intermittent Cloth Puller, For Installation On The Table MONIKÄYTTÖÖN

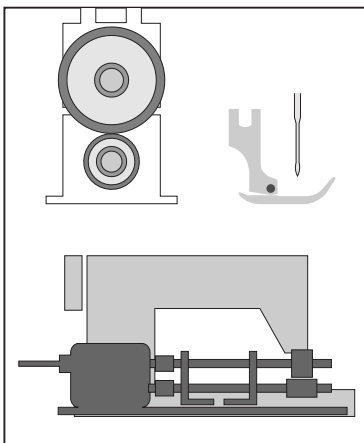

- To be mounted direct on machine table. Appropriate for sewing long sizes of materials, like curtains, bed seats, etc.

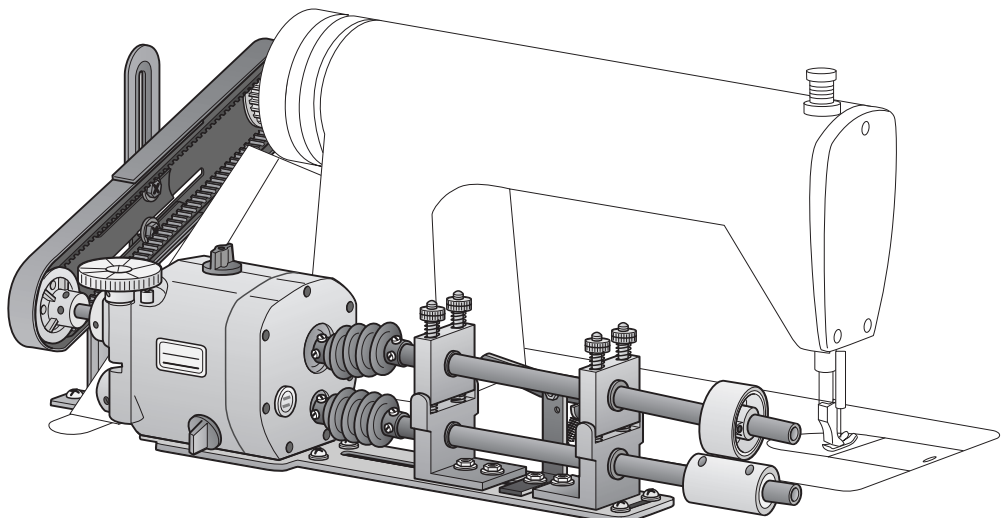
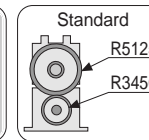
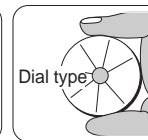
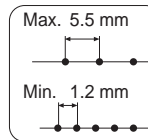
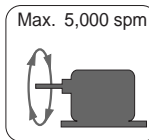
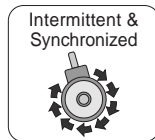

TARKISTA KONEEN MALLI NUMERO ENNEN TILAUSTA

Please specify **model number** of sewing machine when ordering.

INTERMITTENT CLOTH PULLERS, PULLERIT

Attachments

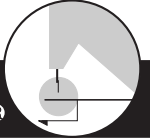

PULLERS RELEVABLES
PULLER INTERMEDIO

INTERMITTIERENDE STOFFPULLER
间歇拉布器

SUISEI®

Rollers for SP90 VETORULLAT

All rubber rollers are made of urethaneform and aluminium.

- For SP90-RF, TR << For Single Yoke Holder >>

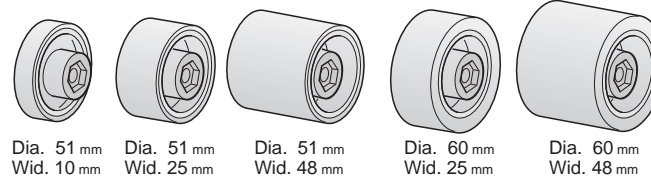

URP-3570
Under Roller Plate

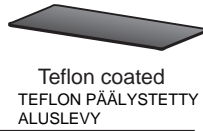

- For SP90-F, BL

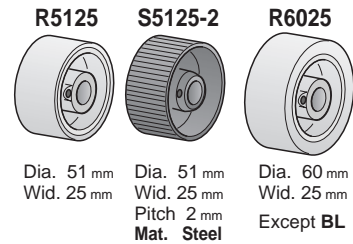

- For SP90-F

Rubber Roller Lower (Box)

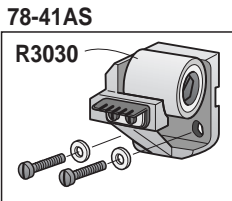

- For SP90-BL

Rubber Roller Lower



Rollers for SP78Z VETORULLAT

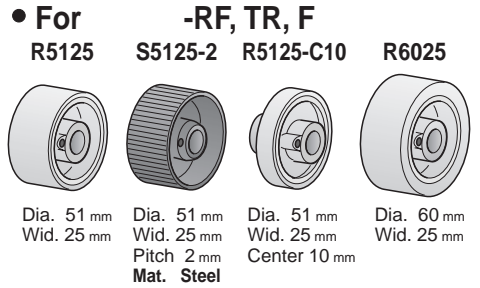

- For -RF, TR, F
- Rubber Roller for 44mm Wid. Holder

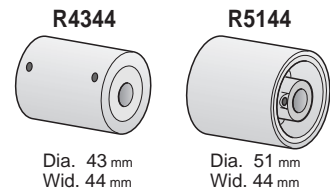

Relay Belt, Roller Holders and Roller Shafts for TR type

HIHNAT, VETORULLAN PITIMET, AKSELIT

- For SP90-TR, -TR

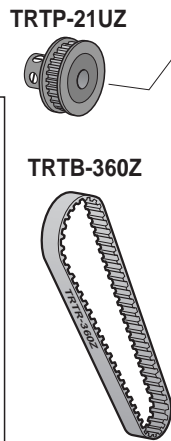
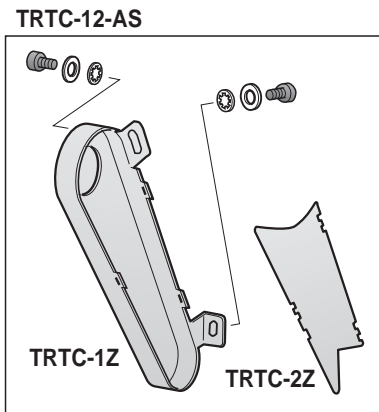

- For SP90-TR

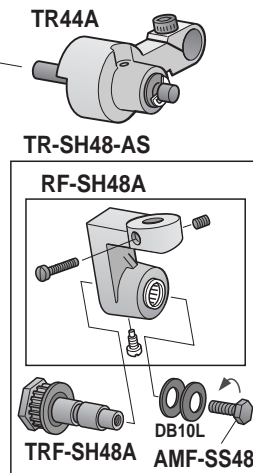

- For -TR

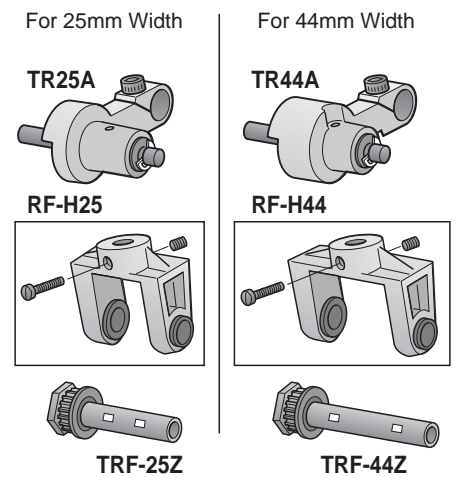

Roller Holders and Roller Shafts for RF, F type

VETORULLANPITIMET, AKSELIT

- For SP90-RF

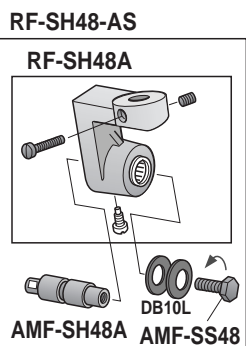

- For SP90-F or

For 25mm Width

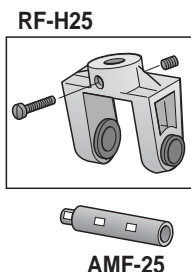

- RF, F

For 44mm Width

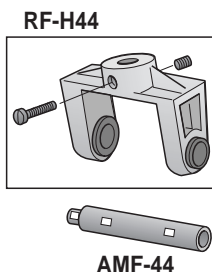

Universal Joint Complete

LIITOSKAPPALEET

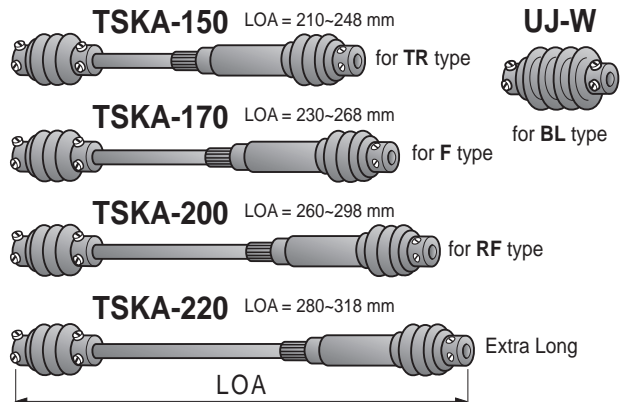

INTERMITTENT CLOTH PULLERS, PULLERIT

Attachments

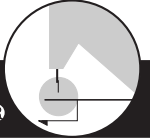

PULLERS RELEVABLES
PULLER INTERMEDIO

INTERMITTIERENDE STOFFPULLER
间歇拉布器

SUISEI®

AMS-... Studs, Regular Type NORMAALI TYYPPI

AMS-1

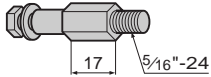

SINGER 281, 291, 261, 331K, 491
JUKI DDL-, DLN-, LH-class, LUH
BROTHER B763, B845-400
MITSUBISHI DB-, DV-, DY-, DN-class
SEIKO LD-28, 38
TOYOTA D146, 348, 530, AD-156, 740
L2512, 252, AL-252
CONSEW 230, 240, 275, 310, 325, 345

AMS-3

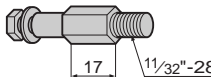

BROTHER 714, 745, 755, 757, 781, 790
792, 831, 832, 835, 841, 842
845, 871, 872, 875, 962
MITSUBISHI DB-120, 130, 320, DX-370
DY-330, 337, DM-420
LT2-220, 240

AMS-6

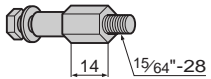

PEGASUS W63
NEW LONG DN-2

AMS-8

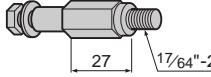

SEIKO STW-class, LSW-class
LTW-class
CONSEW 226R, 255R, 327RB, 332R

AMS-22E

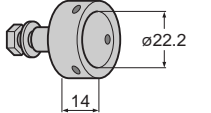

SINGER 457G, 491G, 591, 212U
JUKI LZ-1280, 1286
DÜRKOPP All models
PFAFF 100-class, 1000-class
LEWIS 150-class
TREASURE BS-100
YAMATO DP-1000, DS, DV, DW-class

AMS-22L

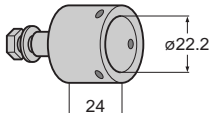

PFAFF 400-class, 5000-class

AMS-... Studs, For Automatic Thread Trimmer AUTOMAATTISELLE LANGAN KATKAISIJALLE

AMS-3-12

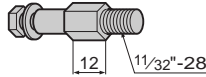

MITSUBISHI
DB-189, 199
DY-339, 349
DN-275-A

AMS-M190

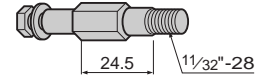

MITSUBISHI
LS2-190
LT2-230, 250

AMS-3-23

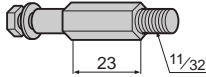

BROTHER
B737 series
B738 series

AMS-1-38

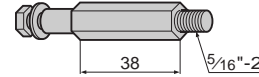

JUKI
DDL-555-2
DLU-450-4
DLU-490-4
DMN-530-4
MH-484-4

AMS-W Cap Screw for AMS-1, AMS-3

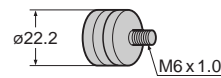

AMS-WE Cap Screw for AMS-22E, AMS-22L

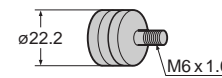

Exchange a cap screw **AMS-W** or **AMS-WE** for a hexagon headed bolt of the studs, when adapting synchronizer of thread trimming machine.

AMS-... Studs, For Feed Off The Arm Machine VAPAAVARSIKONEILLE

AMS-F

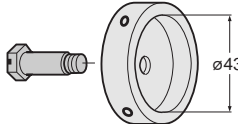

SINGER 231
JUKI MS-19, 26
MS-191, 261

AMS-S261

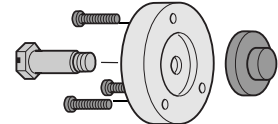

SINGER 261

AMS-1

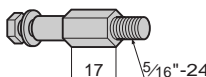

TOYOTA L2512
CONSEW 345

AMS-WF Cap Screw for AMS-F, AMS-S261

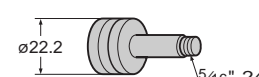

AMS-... Studs, For Automatic Thread Trimmer (Component type) AUTOMAATTISELLE LANGAN KATKAISIJALLE (ERILLISKOMPONENTTI)PULLE

AMS-B715

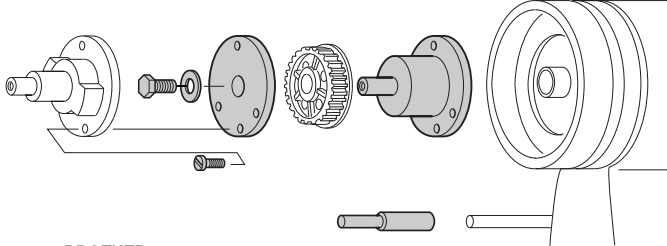

BROTHER
B715, B716, B747 B791-300 B793-300 B795-300
B768-300 B832-400 B835-400 B837-300

AMS-J50

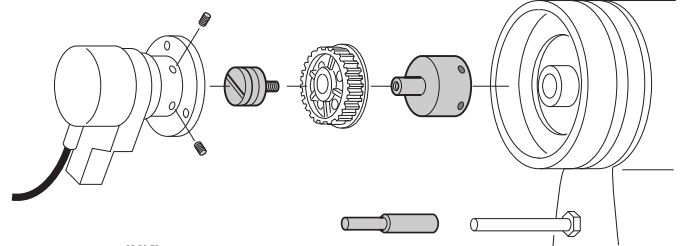

JUKI
DDL-555-4 (PANASONIC)
DDL-550 (PANASONIC)

AMS-J11

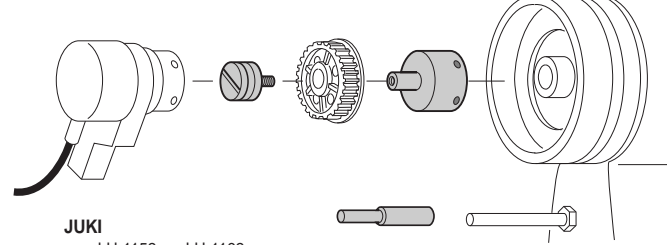

JUKI
LH-1152 LH-1162
LH-1172 LH-1182

AMS-T15

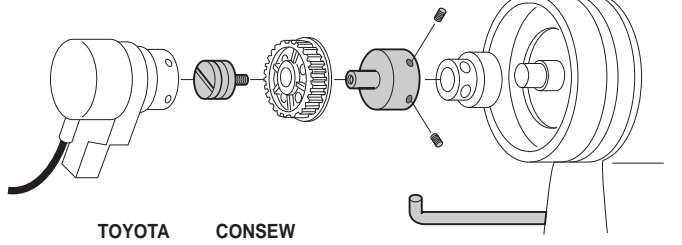

TOYOTA AD-157
CONSEW 290

INTERMITTENT CLOTH PULLERS, PULLERIT

Attachments

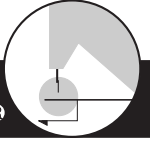

PULLERS RELEVABLES
PULLER INTERMEDIO

INTERMITTIERENDE STOFFPULLER
间歇拉布器

SUISEI®

AMTP-1A, AMTP-1B, AMTB-... Timing Pulleys and Timing Belts HAMMASPYÖRÄT JA HAMMASHIHNAT

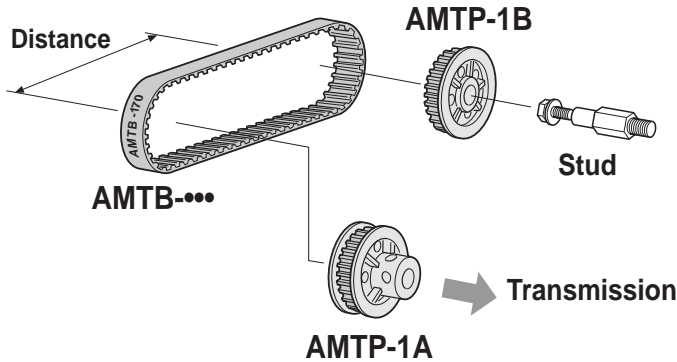

Parts Number	Distance	Teeth	Circumference
AMTB -160	137 mm	5.4 "	137 mm 16 "
-170	150 "	5.9 "	150 " 17 "
-176	157 "	6.2 "	157 " 17.6 "
-180	163 "	6.4 "	163 " 18 "
-190	175 "	6.9 "	175 " 19 "
-200	188 "	7.4 "	188 " 20 "
-210	201 "	7.9 "	201 " 21 "
-220	213 "	8.4 "	213 " 22 "
-230	226 "	8.9 "	226 " 23 "
-240	239 "	9.4 "	239 " 24 "
-250	251 "	9.9 "	251 " 25 "
-260	264 "	10.4 "	264 " 26 "
-270	277 "	10.9 "	277 " 27 "
-280	290 "	11.4 "	290 " 28 "
-300	315 "	12.4 "	315 " 30 "
-360	391 "	15.4 "	391 " 36 "

- Keep appropriate tension on Timing Belt. Too tight cause breakage of the shaft and too loose may cause jumping or slipping from the timing pulley.

RL-600 Roller Lifter Asm. NOSTOVAIJERI KOMP.

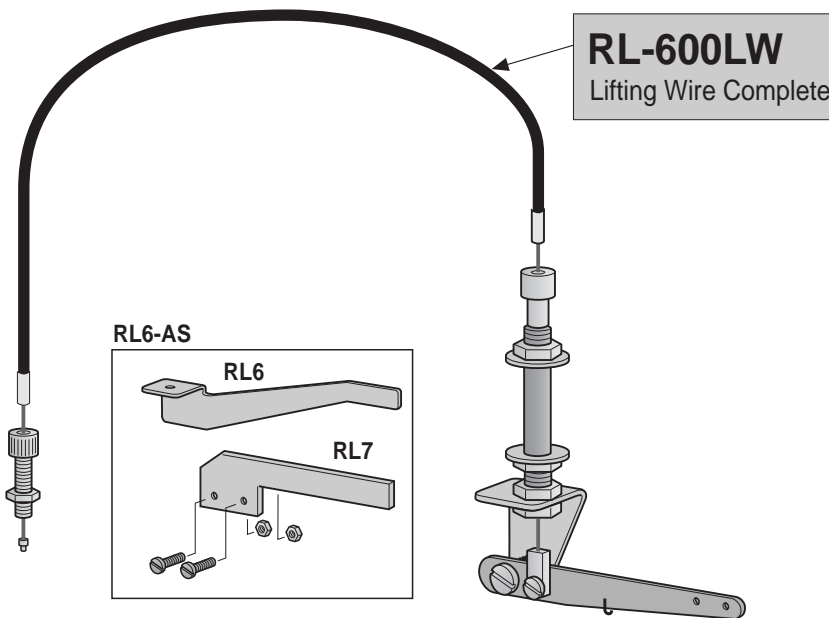

KA7801 Automatic Transmission Fluid



- For the transmission of SP90 or SP78Z.

RFB-T-AS Mount Base Asm. Table Install Type

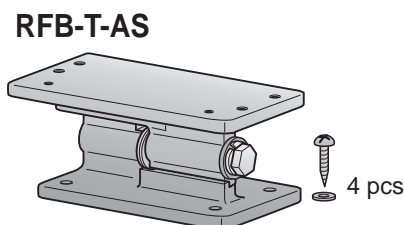

RFB-EP20-AS Extension Plate for RFB-E ALUSLEVY

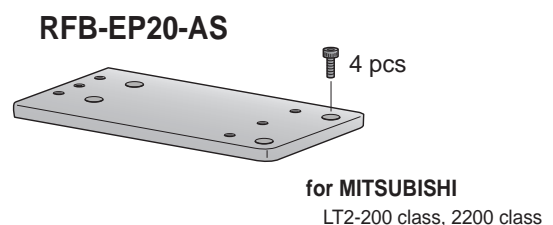

INTERMITTENT CLOTH PULLERS, PULLERIT

PULLERS RELEVABLES
PULLER INTERMEDIO

INTERMITTIERENDE STOFFPULLER
间歇拉布器

Attachments

SUISEI

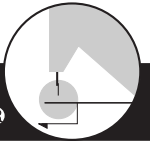

K78CL-01SAD24

Pneumatic Roller Lifter Asm.
PAINELMANOSTOVAIJERI KOMPL.

NM6106S19

K78CL-SVD24
Only Solenoid Valve

Specifications

Cylinder Stroke	8mm (5/16")
Air Operating Pressure	3.5~6.0 kg /cm²
Air Connect Size	M5 x 0.8
Lubrication	Oilless
Voltage (Constant Rate)	DC24V
Optional Voltage	AC100V

K78CL-01SA100

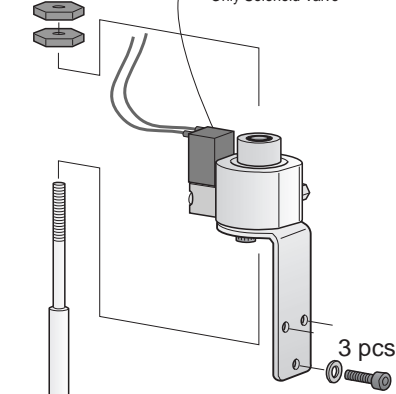

RS280

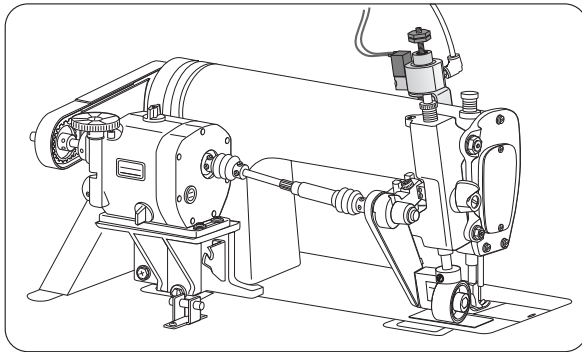

- Always purified air must be delivered to the air cylinder through an air filter so as to avoid a trouble on the solenoid valve.

K78CL-D24

Pneumatic Lifter & Filter Set
PAINELMANOSTOVAIJERI JA
ILMANSUODATIN

K78CL-01SAD24 + K78CL-AIRA

- Set pneumatic roller lifter (DC24V) and air filter unit complete.

K78CL-AIRA

Air Filter Unit Complete
ILMANSUODATIN YKSIKKÖ

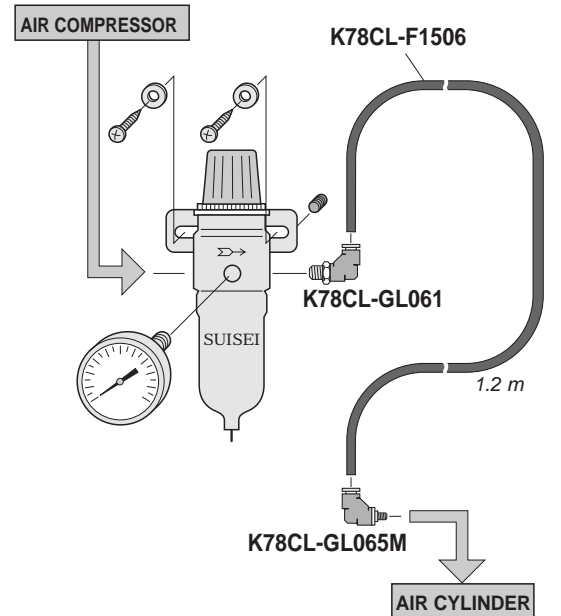

K90KL-SZ

Knee Switch Built In Relay Asm.
POLVIKYTKIN KOMPL.

K90KL-SW
Only Switch Unit

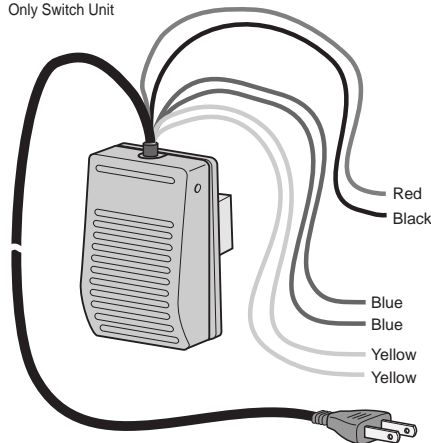

K90KL-AMP Splicing Connector



2 pcs

K90KL-CE2 Insulated Cap Connector



4 pcs

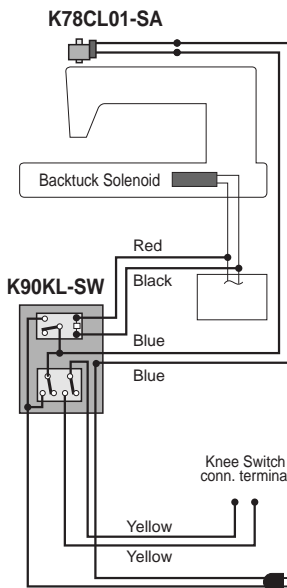

K78CL-KLS^D_S

Knee Switches
POLVIKYTKIMET

K78CL-KLSD
(6 wires)

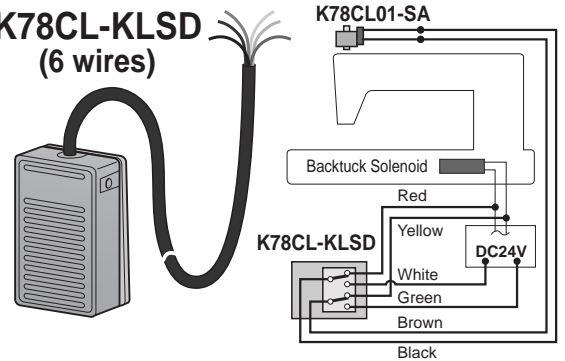

K78CL-KLSS
(2 wires)

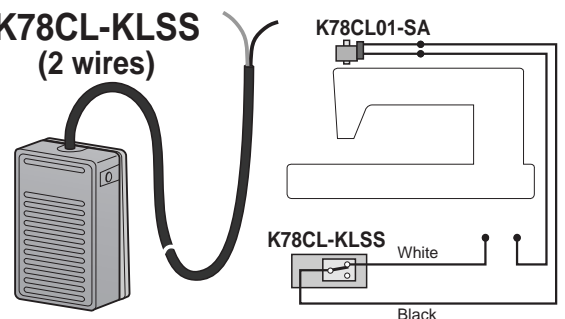

INTERMITTENT CLOTH PULLERS, PULLERIT

Attachments

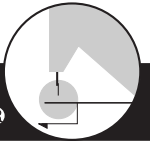

PULLERS RELEVABLES
PULLER INTERMEDIO

INTERMITTIERENDE STOFFPULLER
间歇拉布器

SUISEI®

RF-SB-AS, RF-LBE-AS, RF-GBE-AS

Standard Face Plates for SP90-RF, TR (SP78Z-RF, TR)
STANDARDI ETULEVUT SP90-RF, TR

<p>90-3012AJ</p> <p>78-31AJ</p> <p>78-32AJ</p>	<p>90-3012A</p> <p>78-31A</p> <p>78-32A</p>	<p>RF-SB-AS for RF-S, TR-S</p>	<p>RF-LBE-AS for RF-L, TR-L</p>	<p>RF-GBE-AS for RF-G, TR-G</p>
---	--	---------------------------------------	--	--

RG-G.....

Face Plates for SP90-RF, TR (SP78Z-RF, TR)
ETULEVYT

RF-GJ115-AS

JUKI LH-1152

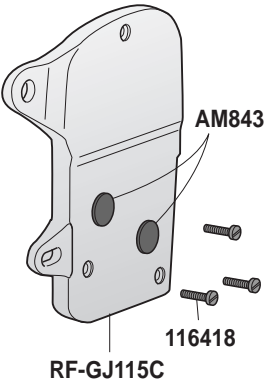

RF-GJ541C

JUKI DLN-5410

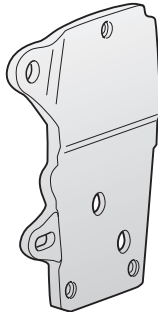

RF-GJ549C

JUKI DLU-5490

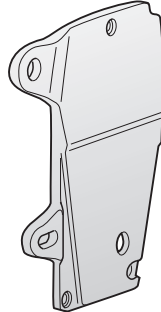

RF-GJ555C

JUKI DDL-5550

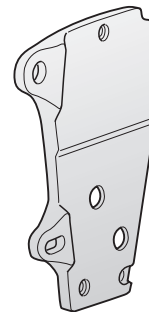

RF-GJ312C

JUKI LH-3128, 3168

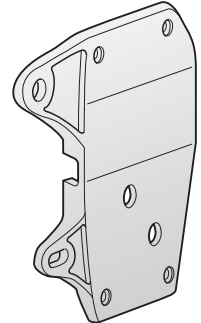

RF-GA467-AS

ADLER 467, 367

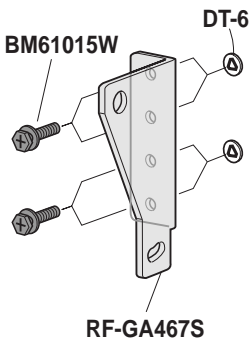

RF-GB737C

BROTHER B737, B738

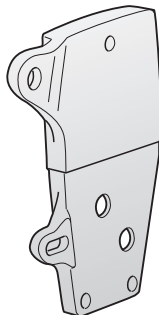

RF-GB845-AS

BROTHER B845

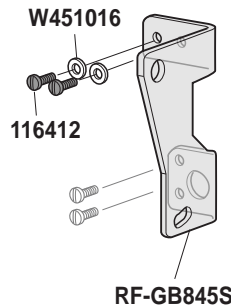

RF-FB925-AS

BROTHER B925, B926

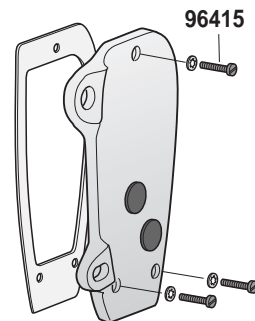

RF-FJ191-AS

JUKI MS-191, 261

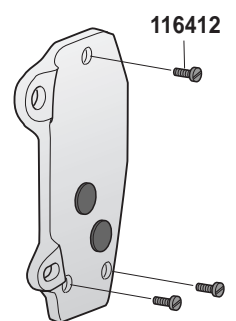

For SP90-FBS

For SP90-FJS

• Please specify **model number** of sewing machine concerning your inquiry except above face plates.